

Waste Isolation Pilot Plant
Compliance Certification Application
Reference 47

Beauheim, R.L., B. W. Hassinger, and J.A. Klaiber, 1983.
Basic Data Report for Borehole Cabin Baby-1 Deepening and Hydrologic Testing,
WTSD-TME-020, Albuquerque, NM, U.S. DOE.

A Facsimile Report

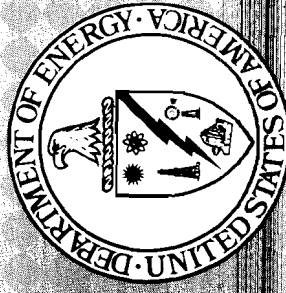

Reproduced by

PHOTODUPLICATION SERVICE

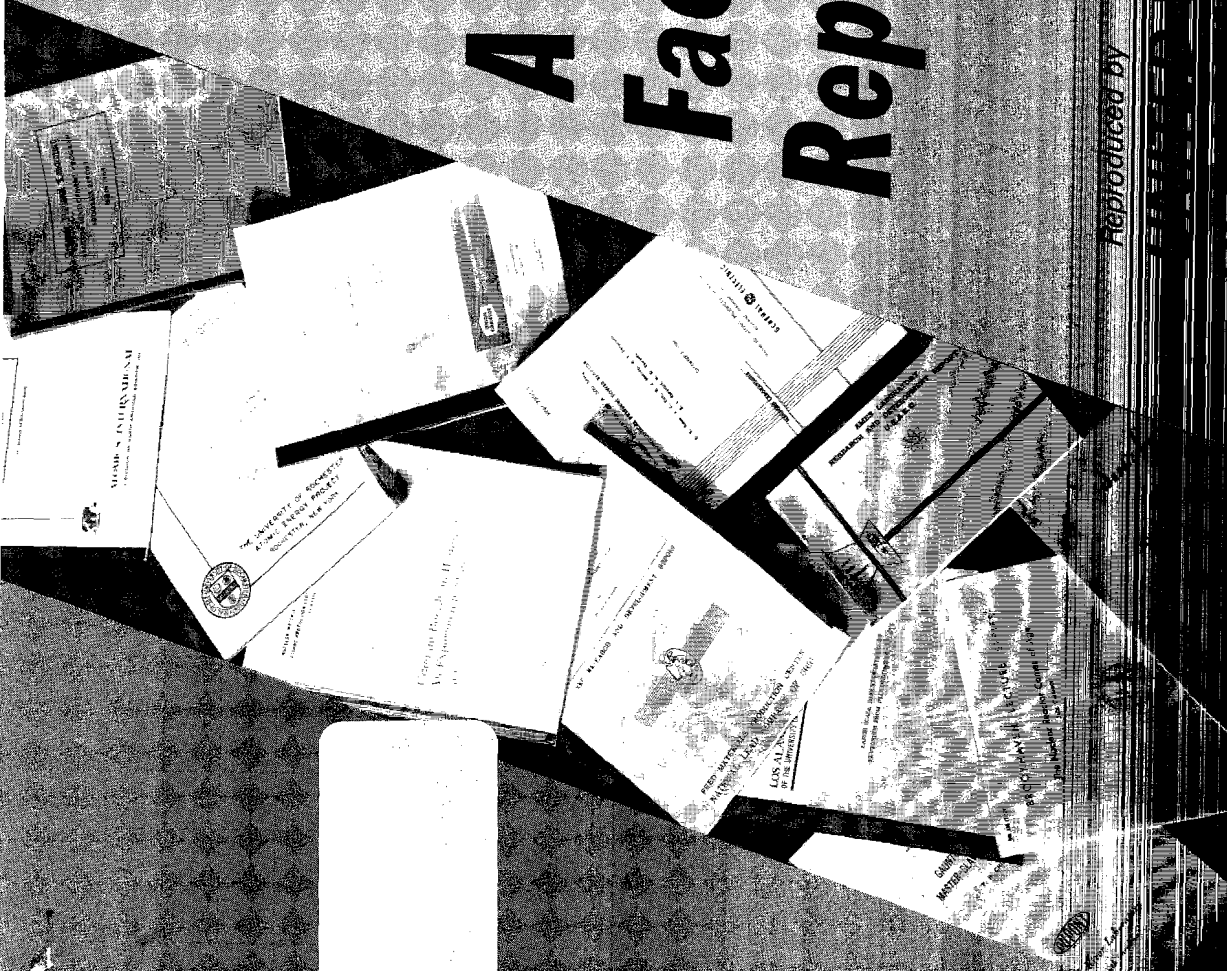

WTSD-TME-020

BASIC DATA REPORT FOR
BOREHOLE CABIN BABY-1 DEEPENING AND HYDROLOGIC TESTING
WASTE ISOLATION PILOT PLANT (WIPP) PROJECT
SOUTHEASTERN NEW MEXICO

DECEMBER, 1983

DISCLAIMER

This report was prepared as an account of work sponsored by an agency of the United States Government. Neither the United States Government nor any agency thereof, nor any of their employees, makes any warranty, express or implied, or assumes any legal liability or responsibility for the accuracy, completeness, or usefulness of any information, apparatus, product, or process disclosed, or represents that its use would not infringe privately owned rights. Reference herein to any specific commercial product, process, or service by trade name, trademark, manufacturer, or otherwise does not necessarily constitute or imply its endorsement, recommendation, or favoring by the United States Government or any agency thereof. The views and opinions of authors expressed herein do not necessarily state or reflect those of the United States Government or any agency thereof.

U.S. Department of Energy
Waste Isolation Pilot Plant
Albuquerque, New Mexico

BASIC DATA REPORT FOR
BOREHOLE CABIN BABY-1 DEEPENING AND HYDROLOGIC TESTING
WASTE ISOLATION PILOT PLANT (WIPP) PROJECT
SOUTHEASTERN NEW MEXICO

AUTHORS:

Richard L. Beauheim

Richard L. Beauheim
D'Appolonia Consulting Engineers, Inc.

12/20/83

Date

Bruce W. Hassinger

Bruce W. Hassinger
D'Appolonia Consulting Engineers, Inc.

12/20/83

Date

Jeffrey A. Klaiber

Jeffrey A. Klaiber
D'Appolonia Consulting Engineers, Inc.

12/20/83

Date

APPROVED FOR SUBMITTAL TO WESTINGHOUSE BY:

Joseph K. Register

Joseph K. Register
D'Appolonia Consulting Engineers, Inc.

12/20/83

Date

COGNIZANT MANAGER:

C. C. Little

C. C. Little
Westinghouse Electric Corporation

12/21/83

Date

MASTER

TABLE OF CONTENTS
 BASIC DATA REPORT FOR BOREHOLE
 CABIN BABY-1 DEEPENING AND HYDROLOGIC TESTING

	<u>Page</u>
TABLE OF CONTENTS	i
LIST OF TABLES	iii
LIST OF FIGURES	iv
1.0 ABSTRACT	1-1
2.0 INTRODUCTION	2-1
2.1 THE PURPOSE OF THE WIPP	2-1
2.2 THE PURPOSE OF DEEPENING CABIN BABY-1	2-2
3.0 GEOLOGIC DATA	3-1
3.1 ABSTRACT	3-1
3.2 INTRODUCTION	3-1
3.3 DESCRIPTION OF CABIN BABY-1 DEEPENING	3-2
3.4 STRATIGRAPHY	3-4
4.0 HYDROLOGIC TESTING	4-1
4.1 PURPOSES OF TESTING	4-1
4.2 TEST INTERVAL SELECTION	4-2
4.3 TEST METHODS	4-3
4.4 INSTRUMENTATION	4-5
4.5 TEST DATA ANALYSIS METHODS	4-6
4.5.1 Flow Period Data Analysis	4-6
4.5.2 Buildup Period Data Analysis	4-8
4.6 TEST RESULTS	4-9
4.6.1 DST-4178: Hays Sandstone	4-9
4.6.2 DST-4138: Olds Sandstone	4-10
4.6.3 DST-4100: Ramsey Sandstone	4-11
4.6.4 DST-4044: Lamar Limestone	4-12
4.6.5 DST-765: Salado Formation	4-12

TABLE OF CONTENTS
(continued)

	<u>Page</u>
4.7 HYDROGEOCHEMICAL SAMPLING	4-13
4.7.1 Hays Sandstone Fluid Sampling	4-15
4.7.2 Olds Sandstone Fluid Sampling	4-15
4.7.3 Ramsey Sandstone Fluid Sampling	4-16
4.7.4 Bell Canyon Fluid Sampling	4-17
4.8 PRESENT WELL CONDITION	4-18
REFERENCES	
TABLES	
FIGURES	
APPENDIX A - JUSTIFICATION	
APPENDIX B - FIELD OPERATIONS PLAN	
APPENDIX C - BOREHOLE HISTORY	

LIST OF TABLES

<u>TABLE NO.</u>	<u>TITLE</u>
1	Abridged History of Borehole Cabin Baby-1
2	Stratigraphic Summary of Borehole Cabin Baby-1
3	Lithologic Log of Deepened Portion of Cabin Baby-1
4	Cabin Baby-1 Sperry-Sun Directional Survey
5	Hydrologic Testing Activity Summary
6	Summary of DST Results
7	Chemical Composition of Fluids, Bell Canyon Formation, Cabin Baby-1

LIST OF FIGURES

<u>FIGURE NO.</u>	<u>TITLE</u>
1	Location of the WIPP Site and Borehole Cabin Baby-1
2	Plan of the WIPP Site and Location of Borehole Cabin Baby-1
3	As-Built Conditions After Deepening Borehole Cabin Baby-1
4	Geophysical and Lithologic Logs for Cabin Baby-1
5	Cabin Baby-1 Borehole Orientation
6	Straddle Packer Assembly Configuration
7	Schematic Diagram of Data Acquisition System
8	Real-Time Plot of DST-4178: Hays Sandstone
9	Horner Plot of DST-4178/FBU
10	Horner Plot of DST-4178/SBU
11	Early-Time Slug Test Plot for DST-4178/SFL
12	Slug Test Plot for DST-4178/SLUG
13	Real-Time Plot of DST-4138: Olds Sandstone
14	Horner Plot of DST-4138/FBU
15	Horner Plot of DST-4138/SBU
16	Early-Time Slug Test Plot for DST-4138/SFL
17	Early-Time Slug Test Plot for DST-4138/SLUG
18	Real-Time Plot of DST-4100: Ramsey Sandstone
19	Horner Plot of DST-4100/FBU
20	Horner Plot of DST-4100/SBU
21	Early-Time Slug Test Plot for DST-4100/SFL
22	Early-Time Slug Test Plot for DST-4100/SLUG
23	Real-Time Plot of DST-4044: Lamar Limestone
24	Horner Plot of DST-4044/FBU
25	Expanded-Scale Horner Plot of DST-4044/FBU
26	Real-Time Plot of DST-765: Salado Formation
27	Horner Plot of DST-765/SBU
28	Expanded-Scale Horner Plot of DST-765/SBU
29	Early-Time Slug Test Plot for DST-765/SLUG
30	Thiocyanate Concentration vs. Volume Swabbed, DST-4178, Cabin Baby-1

1.0 ABSTRACT

Borehole Cabin Baby-1 was originally drilled to a depth of 4159.0 feet below kelly bushing (8.0 feet above ground surface) in 1974 and 1975 as a "wildcat" hydrocarbon exploratory well. Control of the borehole was given to the U.S. Department of Energy (DOE) after it was found to be a "dry hole". Cabin Baby-1 was reentered, deepened, and hydrologically tested in August and September, 1983. The well is located in Section 5, T23S, R31E, just outside the limit of WIPP Zone III, approximately 2.5 miles south of the WIPP exploratory shaft.

The deepening and testing of Cabin Baby-1 was undertaken for several reasons:

- To provide data on the hydrologic properties, including hydrostatic head potential of selected permeable zones in the Bell Canyon Formation.
- To provide representative fluid samples from selected permeable zones in the Bell Canyon Formation for determination of fluid composition and density.
- To define further the stratigraphy of the upper Bell Canyon Formation at the Cabin Baby-1 location.

The borehole was deepened from the previous total depth to a new depth of 4298.6 feet below kelly bushing by continuous coring. Field operations related to deepening and logging of the borehole began August 12, 1983 and were completed August 30, 1983. Hydrologic testing activities began August 30, 1983 and were completed September 29, 1983. Drill-stem tests were conducted in four zones in the Bell Canyon Formation, and one test of the Salado Formation was performed. Fluid samples were collected from the Hays and Olds sandstones of the Bell Canyon Formation.

2.0 INTRODUCTION

This document presents data collected during the reentering, deepening (coring), and hydrologic testing of Cabin Baby-1. Cabin Baby-1 was initially drilled between May 31, 1974 and February 8, 1975 to a depth of 4159.0 feet⁽¹⁾ as a wildcat hydrocarbon well. The existing documentation on the initial drilling consists of a U.S. Geological Survey (USGS) Well Completion Report and a production and drilling activity summary (Grace, 1974a,b,c, 1975). No lithologic descriptions were included in this documentation. Cabin Baby-1 was deepened by coring from 4159.0 feet to a depth of 4298.6 feet between August 17, 1983 and August 19, 1983. Drill-stem tests were performed in the Bell Canyon and Salado formations in Cabin Baby-1 between August 30, 1983 and September 29, 1983. The locations of Cabin Baby-1 and the WIPP site are shown in Figures 1 and 2.

The original scope of work for the Cabin Baby-1 reentry was developed by Sandia National Laboratories (SNL; Appendix A). All work performed in the development of this report, including field work and report preparation, was performed in accordance with standard D'Appolonia quality control (QC) and quality assurance (QA) procedures. All work was subject to QA audit review. Copies of audit memos and responses are on file in the QA file of D'Appolonia Consulting Engineers, Inc., Albuquerque, New Mexico.

2.1 THE PURPOSE OF THE WIPP

The WIPP is being developed by the U.S. Department of Energy (DOE) to demonstrate safe, permanent disposal of transuranic (TRU) radioactive waste from the U.S. defense programs. In addition, the WIPP includes underground research facilities to investigate interactions between bedded salt and high-level radioactive wastes.

⁽¹⁾All reported depths are depths below kelly bushing (8.0 feet above the ground surface). Ground surface elevation at the time of initial drilling was approximately 3320 feet.

WTSD-TME-020

Additional information on the WIPP and characterization of the WIPP site may be found in Powers et al. (1978) and U.S. DOE (1983).

2.2 THE PURPOSE OF DEEPENING CABIN BABY-1

Cabin Baby-1 was deepened in August, 1983 to expand the hydrology data base of the Bell Canyon Formation in the vicinity of the proposed WIPP. The Bell Canyon Formation is the nearest fluid-bearing formation underlying the WIPP facility considered capable of transporting fluid regionally. Hydrologic information was obtained to define the hydraulic properties and head potential of Bell Canyon Formation. A more detailed discussion of the objectives and justification of deepening Cabin Baby-1 is included in Appendix A, "Justification", and in Appendix B, "Field Operations Plan".

3.0 GEOLOGIC DATA

3.1 ABSTRACT

Cabin Baby-1 is located approximately 2.5 miles south of the exploratory shaft at the WIPP site in Eddy County, New Mexico (Figure 1). Deepening of Cabin Baby-1 was performed primarily to permit hydrologic testing in zones within the Bell Canyon Formation below the well's previous total depth (TD). Coring was performed from August 17, 1983 to August 19, 1983 from a depth of 4159.0 feet to a new TD of 4298.6 feet below the rig kelly bushing (KB).

The entire cored section (4159.0 feet to 4298.6 feet below KB) was in the Bell Canyon Formation, and consists of siltstone, shale, and sandstone. Four-inch core was recovered, and is stored in the DOE core library in Carlsbad, New Mexico. No unusual lithologic or structural features were observed in Cabin Baby-1, and no gas was encountered. The rock unit thicknesses were consistent with those at other DOE drillholes penetrating the Bell Canyon Formation (SNL and D'Appolonia, 1982, 1983; SNL and USGS, 1983).

3.2 INTRODUCTION

Cabin Baby-1, initially drilled as a wildcat hydrocarbon exploratory well, was deepened to perform hydrologic characterization of the Bell Canyon Formation. SNL prepared the initial scope of work for the hole. Drilling, borehole geophysics, and hydrologic instrumentation were contracted by the Technical Support Contractor (TSC) on behalf of the DOE. Testing activities and supervision of field operations were performed by representatives of D'Appolonia Consulting Engineers, Inc. and Westinghouse Electric Corporation. Table 1 presents an abridged history of Cabin Baby-1.

All measurements related to the borehole are reported in the inch-pound (English) system. These units are used to facilitate direct comparison of measurements made by drillers in reporting well depths for cores, and

by geophysical loggers in recording in-hole variations in rock properties with depth. All depths are measured from the kelly bushing, eight feet above ground level. If metric units are desired, the following conversion factors should be used:

<u>MULTIPLY ENGLISH UNIT</u>	<u>BY</u>	<u>TO OBTAIN METRIC UNIT</u>
Foot (ft)	0.3048	Meter (m)
Inch (in)	25.4	Millimeter (mm)
Inch (in)	2.54	Centimeter (cm)
Pounds per Square Inch (lb/in ²)	0.006895	Megapascal (MPa)

3.3 DESCRIPTION OF CABIN BABY-1 DEEPENING

Cabin Baby-1 is located in the northeast quarter, 1980 feet from the north line (FNL) and 1980 feet from the east line (FEL) of Section 5, T23S, R31E in Eddy County, New Mexico (Grace, 1975). Deepening, geophysical logging, and hydrologic testing of Cabin Baby-1 were performed between August 12, 1983 and September 29, 1983. During this period, twenty-nine days were devoted to hydrologic testing of the Bell Canyon and Salado formations. The total depth penetrated was 4298.6 feet below kelly bushing. Table 2 presents a stratigraphic summary of Cabin Baby-1. The as-built configuration of Cabin Baby-1 after deepening is depicted in Figure 3. A detailed description of the hydrologic testing activities is presented in Chapter 4.

Field activities began by identifying the cause of borehole blockage previously encountered by SNL at about 3400 feet when the hole was reentered in July, 1983. Several "bridges" were encountered as drill pipe was inserted into the borehole on August 15, 1983, but were passed by circulating mud and rotating through the obstructions. A formation or undisturbed zone was encountered at 4159.0 feet. Magnetic fishing equipment was used to remove ferrous material possibly remaining in the hole after the 1974-1975 drilling. The fishing equipment showed no evidence of metal at 4159.0 feet. To determine the stratigraphic depth

of the borehole and the amount of deepening necessary for hydrologic testing, as well as to determine the condition of the hole, the following geophysical logs were run by Dresser Atlas prior to deepening:

- Limestone-compensated neutron porosity
- Gamma ray
- 4-arm caliper

The logs did not provide a conclusive indication of stratigraphic depth, so the decision was made to deepen the hole.

The coring to the final TD (4298.6 feet) was rapid and trouble-free. The lithologic description presented in Table 3 is based on examination of core recovered during drilling. Four-inch (diameter) core (7-27/32 inch OD bit) was recovered from 4159.0 feet to 4298.6 feet. The entire interval was cored to aid in defining the permeable zones of the Bell Canyon Formation. To determine if sufficient depth (i.e., Hays sandstone penetrated) for the hydrologic testing had been obtained, Dresser Atlas ran the following geophysical logs:

- Limestone-compensated neutron porosity
- Gamma ray
- Single-arm caliper

These logs indicated that the hole terminated within the Hays sandstone member of the Bell Canyon Formation, and hence no further deepening was deemed necessary.

In preparation for the hydrologic testing program, the borehole was reamed from about 3400 feet to TD (4298.6 feet) with a 9-7/8 inch bit and stabilizers (reamers). At the completion of reaming, the USGS ran the following geophysical logs:

- 3-arm caliper
- Gamma ray
- Neutron porosity
- Neutron density
- Acoustic televiewer

These logs were used to identify the stratigraphy of the hole above the Bell Canyon Formation.

Dresser Atlas ran the following geophysical logs at the completion of reaming:

- Dual laterolog
- Micro laterolog
- Gamma ray

Figure 4 presents the results of gamma ray, neutron porosity, and neutron density logs performed by the USGS, and dual and micro laterologs performed by Dresser Atlas. The Bell Canyon stratigraphy and DST depths were determined from the Dresser Atlas logs.

The USGS logging depths were incorrect due to a problem in the cable drive unit of the logging truck. The depths were corrected by adjusting the Castile-Bell Canyon contact on each log to the depth established for that contact from the Dresser Atlas logs. An upward adjustment of 16 feet or less was required in each case. Following the hydrologic testing, Sperry-Sun, Inc., ran a directional survey in the well. This survey revealed a departure from vertical of about 131 feet at a depth of 4200 feet (Table 4, Figures 4 and 5). Copies of all logs (including those not presented herein) are on file with the U.S. Geological Survey and D'Appolonia Consulting Engineers, Inc. in Albuquerque, New Mexico.

3.4 STRATIGRAPHY

Cabin Baby-1 penetrated rocks in descending order from Quaternary to Permian in age. The sequence was normal for the area with no anomalously thick or thin units, and no highly fractured zones were observed on the televiewer log. The stratigraphic section penetrated during the initial drilling to 4159.0 feet was interpreted from the geophysical log signatures (Figure 4) as follows:

- Quaternary surficial deposits and Gatuna Formation; 0 - 15.5 feet

- Triassic Santa Rosa Formation; 15.5 - 142.8 feet
- Permian Dewey Lake Redbeds; 142.8 - 362.9 feet
- Permian Rustler Formation; 362.9 - 653.0 feet
- Permian Salado Formation; 653.0 - 2703.5 feet
- Permian Castile Formation; 2703.5 - 4045.0 feet
- Permian Bell Canyon Formation; 4045.0 - TD

Stratigraphic information, including key marker beds for these formations, is summarized in Table 2 and presented graphically in Figure 4. Because the hole is cased above 660 feet, the locations of geologic contacts and marker beds above this depth are uncertain.

When Cabin Baby-1 was originally drilled in 1974 and 1975, 114.0 feet of the Bell Canyon Formation was penetrated. The initial drilling was terminated in the Olds sandstone member of the Bell Canyon Formation. The deepening (4159.0 to 4298.6 feet) extended the borehole through the Olds sandstone into the Hays sandstone member. The stratigraphic section of the Permian Bell Canyon Formation penetrated in the initial drilling and deepening, interpreted from the geophysical log signatures, includes the following informal members:

- Lamar limestone 4045.0 - 4086.0 feet
- Ramsey sandstone 4086.0 - 4132.0 feet
- Ford shale 4132.0 - 4140.0 feet
- Olds sandstone 4140.0 - 4171.0 feet
- Hays sandstone 4171.0 - TD

The Permian Bell Canyon Formation contains shales, calcareous and argillaceous siltstones, silty fine-grained sandstones, and limestones. These clastic sediments were laid down as basin sediments at about the same time as the Capitan reef (Capitan Limestone) was forming, when basin subsidence was lessening (Powers et al., 1978).

The Lamar limestone, Ramsey sandstone, and Ford shale were cored at ERDA-10 (SNL and USGS, 1983). Only the Ramsey sandstone, a very fine-grained silty sandstone and siltstone, was clearly distinguishable in core. The Lamar limestone member, identified by the geophysical logs, consisted of interbedded limestone, calcareous siltstone, and calcareous shale. The Ford shale occurred within a very fine grained sandstone unit containing chips of grayish-black shale.

Drillhole AEC-7 (SNL and D'Appolonia, 1982) penetrated with rock coring the Lamar limestone, Ramsey sandstone, Ford shale, and Olds sandstone. At AEC-7 the Lamar limestone and Ramsey sand were described similarly as at ERDA-10 (SNL and USGS, 1983). The Ford shale consisted of a light olive-gray, calcareous, sandy siltstone. The Olds sandstone at AEC-7 was described as a light to medium-gray, very fine grained, calcareous sandstone with calcareous siltstone and a trace of silty limestone.

At Cabin Baby-1, the top of the Olds sandstone is at a depth of 4140.0 feet (below kelly bushing). When Cabin Baby-1 was initially drilled, 19.0 feet of the Olds sandstone were penetrated. Thus, no core description of this portion of the Olds sandstone is available.

That portion of the Olds sandstone penetrated during deepening of Cabin Baby-1 (4159.0 to 4171.0 feet) consists of medium-gray to medium-dark-gray, calcareous, carbonaceous siltstone with very fine sand and black, shaley partings and laminae. The Hays sandstone is lithologically very similar, but is generally medium gray and contains more prominent black, shaley or carbonaceous bands (0.01 to 0.03 feet thick) and zones of black, shaley or carbonaceous laminae (0.01 to 0.03 feet thick). Also, it is less calcareous than the Olds, based on a slower reaction to a 10% HCl solution. Table 3 presents a detailed lithologic description of the cored portion of Cabin Baby-1.

4.0 HYDROLOGIC TESTING

The hydrologic testing program for the Cabin Baby-1 well was developed through consultation between the DOE, USGS, D'Appolonia, Westinghouse, and SNL. Upon completion of the deepening and logging of the hole, the available stratigraphic data were presented to the New Mexico Environmental Evaluation Group (EEG; State review group for the WIPP project), and the proposed Bell Canyon testing program (methods to be used, units to be tested, etc.) was outlined for the EEG's information and to solicit their comments. Testing the Salado Formation was added to the program at a later date.

4.1 PURPOSES OF TESTING

Various breach consequence scenarios have been hypothesized for the WIPP which involve interconnection of the WIPP with overlying and/or underlying aquifers through one or more boreholes. As the nearest water-bearing unit/aquifer underlying the WIPP disposal horizon, the Bell Canyon Formation is of concern (in the case of a facility breach) as either a source of water which could flow through the WIPP and into other flow systems such as the Rustler Formation, or as a sink and means of transport for fluids which have become contaminated by passage through the WIPP. To evaluate these concerns, three primary questions must be addressed:

- What is the head potential within the Bell Canyon Formation; i.e., will the Bell Canyon serve as a source or a sink?
- What are the hydraulic properties of the Bell Canyon; i.e., what is the capacity of the formation to produce or accept fluid?
- What are the physical/chemical properties of the Bell Canyon fluids; most importantly, what is the fluid density?

Data relevant to these questions had been collected at boreholes AEC-7 (SNL and D'Appolonia, 1982), AEC-8 (SNL and D'Appolonia, 1983), and

ERDA-10 (SNL and USGS, 1983). Because of the difficulties inherent in testing deep aquifers with low transmissivities, ambiguities remain, particularly with regard to the fluid density and head potential in the Bell Canyon. The objectives of the Cabin Baby testing program, therefore, were to provide better data on the Bell Canyon fluid density and head potential, and to provide additional data on the permeabilities of the water-bearing units within the Bell Canyon.

4.2 TEST INTERVAL SELECTION

Upon completion of the deepening and logging of the hole, the geologic and geophysical data were evaluated to select the intervals in the Bell Canyon Formation to be tested. Five stratigraphic members in the Bell Canyon were identified:

- Lamar limestone 4045.0 - 4086.0 feet
- Ramsey sandstone 4086.0 - 4132.0 feet
- Ford shale 4132.0 - 4140.0 feet
- Olds sandstone 4140.0 - 4171.0 feet
- Hays sandstone 4171.0 - TD

Through consultation between the DOE, SNL, USGS, D'Appolonia, and Westinghouse, the decision was made to test all of the Bell Canyon members except for the Ford shale. The Ramsey, Olds, and Hays sandstones were selected for testing because they are the most porous members of the upper Bell Canyon. The Lamar limestone was selected because it had been tested previously at AEC-7 (SNL and D'Appolonia, 1982), AEC-8 (SNL and D'Appolonia, 1983), and ERDA-10 (SNL and USGS, 1983). Geophysical log signatures indicated the presence of relatively finer grained materials at the member boundaries, thus these zones were selected as packer "seats", with the balance of the units to be tested. This plan met with the agreement of the EEG.

Following the completion of the Bell Canyon tests, the decision was made to straddle the entire Salado Formation plus the Salado-Castile contact to see how much, if any, fluid would be produced. A production-injection packer (PIP) was set at 2725.4 feet below KB 22, feet below

the top of the Castile Formation in Anhydrite III, to isolate the Salado from the formations below. The upper packer seat was selected at the highest elevation possible in the Salado where the hole diameter was small enough for the packer to be able to seat. This location proved to be from 760.8 to 765.0 feet below KB, above Marker Bed 101.

4.3 TEST METHODS

Drill-stem tests (DST) and rising-head "slug" tests were selected as the most appropriate means of quantifying the hydraulic properties of the Bell Canyon Formation. These tests require a packer assembly mounted at the bottom of a tubing string in the hole which isolates the interval to be tested. For a test of the lower portion of a hole, a single packer is used. To test a discrete zone in a hole, a straddle packer arrangement is required. Other necessary equipment includes a shut-in tool operated by a J-slot tool, which inflates and deflates the packer(s) and opens and closes the test interval from the tubing, transducers reading pressures above, below, and between the packers, and a data acquisition system (see Figures 6 and 7). Instrumentation specifications will be discussed below.

The first step in a DST is to select the interval to be tested. The packer separation is then adjusted to correspond to the interval thickness. Next, the packer assembly is run into the hole to the desired depth, and the packers are inflated with the test interval shut-in (closed off) from the tubing above. The fluid in the tubing is swabbed out while the pressure in the test interval stabilizes.

The actual DST begins with opening the shut-in tool, which allows the water in the straddled interval to enter the tubing. Due to the large pressure differential between the tubing and the straddled interval, water under the initial static formation pressure flows rapidly towards the borehole and up the tubing string. This is the first flow period (FFL). This period begins with a drop in pressure from static (shut-in tool closed) to a pressure corresponding to the weight of the water

remaining in the tubing (after swabbing) above the transducer. As water rises up the tubing string, the pressure exerted downward on the straddled interval increases, reducing the pressure differential and thus, the flow rate.

When the flow rate has decreased by about ten to twenty percent, the shut-in tool is closed, stopping the flow of water up the tubing. This is the beginning of the first pressure buildup period (FBU). The formation is allowed to recover in the first pressure buildup period for about three times as long as the first flow period, or longer if necessary to achieve a stable pressure. The shut-in tool is then reopened to initiate the second flow period (SFL). The water level in the tubing will not have changed since the end of the first flow period. The second flow period typically lasts several times as long as the first flow period, again until the flow rate decreases by ten to twenty percent. Again, the shut-in tool is closed and the second buildup period (SBU) begins. This buildup period continues for a period not less than three times the second flow period, and longer if necessary to achieve a stable pressure. These four periods, FFL, FBU, SFL, and SBU, generally constitute a single complete DST.

During the second buildup period of the DST, the fluid is swabbed out of the tubing so that a long-term slug test can be performed. When the pressure has stabilized during the SBU, the shut-in tool is opened. As with the first flow period (FFL) of the DST, the pressure on the transducer initially drops from static reservoir pressure to a pressure corresponding to the weight of the remaining fluid in the tubing above the transducer. As water rises up the tubing string, the pressure on the transducer rises. The slug test consists of monitoring the pressure rise. Ideally, the pressure rise should be monitored until eighty to ninety percent of the pressure lost is recovered, but forty percent recovery is generally adequate to define the shape of the recovery curve, particularly if log-log plotting techniques are used (Ramey et al., 1975).

Pressures above and below the tested interval are monitored during all tests so that any leakage around the packers or other types of flow into the test interval from above or below can be detected. Slow, uniform pressure decreases of a few psi above and below the test interval are not uncommon, as borehole fluids may seep into the adjacent formations. Abrupt, higher magnitude pressure changes may indicate faulty packer seats or other malfunctions.

4.4 INSTRUMENTATION

All instrumentation for the drill-stem testing was supplied by Lynes, Inc., of Houston, Texas. The down-hole equipment consisted of a Lynes inflatable drill-stem test tool, a triple transducer which measured pressure and temperature above, below, and between the packers, and a triple conductor wireline (TCWL) from the transducers to the data acquisition system at the surface (Figure 6). The data acquisition system consisted of a Lynes SC-2 interface unit between the transducer and a HP-5316A frequency counter, a HP-59306A relay actuator, a HP-85A computer with tape drive for data recording, an Epson MX-80 printer for a real-time listing of the data, and a HP-9872B plotter for a real-time plot of the data (Figure 7). The same computer, printer, and plotter system was also used for data reduction and analysis.

For the test on the Salado Formation, a Lynes resettable production-injection packer (PIP) was used to isolate the Salado from lower formations. The Lynes drill-stem test tool with a single packer was set at the top of the Salado. A Lynes Digital Memory Recorder (DMR) 312 was suspended below the PIP to provide a record of the pressure and temperature in the bottom of the hole during the Salado test. Following the completion of the test and retrieval of the PIP and DMR, the bottom-hole data were read out of the DMR using a Digital Surface Recorder (DSR) 300.

4.5 TEST DATA ANALYSIS METHODS

The analyses of the DST data were to produce answers to the following questions:

- What are the hydraulic properties of the tested units?
- What are the static formation pressures in the tested units?

The analytical methods used to answer these questions are discussed below.

4.5.1 Flow Period Data Analysis

The flow period data and slug tests were analyzed by a method first presented by Cooper et al. (1967), and adapted to DST's by Ramey et al. (1975). The method is used for calculating the transmissivity of a homogeneous, isotropic confined reservoir of uniform thickness which is fully penetrated by a well. To initiate a flow period, a hydraulic gradient is established around the well by swabbing the fluid from the tubing with the test interval shut-in, and then opening the test interval to the tubing. The problem is described mathematically by:

$$\frac{\partial^2 h}{\partial r^2} + \frac{1}{r} \frac{\partial h}{\partial r} = \frac{S}{T} \frac{\partial h}{\partial t}$$

where:

- h = hydraulic head at radius r, and time t.
- r = radius from well center
- t = time
- S = formation storativity
- T = formation transmissivity

This equation describes nonsteady, radial flow of groundwater.

The solution to this equation utilized for analysis of flow-period data is presented in the form of curves of $[H/H_0]$ and $[(H_0-H)/H_0]$ versus the

dimensionless time parameter $\beta = Tt/r_c^2$ for each of several values of $\alpha = r_s^2 S/r_c^2$ where:

H_0 = initial (maximum) pressure differential (drawdown)

H = pressure differential at time t

t = time elapsed since test began

r_s = radius of borehole

r_c = inside radius of tubing string

The use of these type curves is similar to the Theis graphical method of pumping test analysis. Plots of the quantities $[H/H_0]$ and $[(H_0-H)/H_0]$ versus t are made on semi-log and log-log paper, respectively, of the same scale as the type curves. Semi-log plotting and type curves are best used when a minimum of about seventy percent recovery has occurred. For lesser degrees of recovery, log-log plotting techniques provide a more definitive type-curve fit (Ramey et al., 1975). The type curves are then placed over the test data and translated horizontally (with the horizontal axes coincident) until a best fit is achieved. In this position a match point is chosen, and the corresponding values of α and β are read from the type curve, and t is read from the data plot. The transmissivity (T) is then calculated from the following rearrangement of the equation presented above using the coordinates of the match point:

$$T = \frac{\beta r_c^2}{t}$$

The hydraulic conductivity, K , can be calculated by dividing the transmissivity by the thickness of the tested interval, b , or $K = T/b$. The permeability, k , may then be calculated from the following relation:

$$k = K \frac{\mu}{\rho} \quad (\text{Freeze and Cherry, 1979})$$

where:

μ = viscosity

ρ = density

4.5.2 Buildup Period Data Analysis

The buildup period data were analyzed using a method developed by Horner (1951). Horner's method is applicable to the buildup (recovery) of a well which fully penetrates a homogeneous, isotropic, horizontal, infinite, confined reservoir following a constant-rate flow period.

Horner's solution is:

$$p(t) = p_s - \frac{162.6qB\mu}{kh} \log \frac{t(\text{flow}) + dt}{dt}$$

where:

- $p(t)$ = pressure at time t , psi
- p_s = static formation pressure, psi
- k = permeability, md
- q = production rate of previous flow period, BPD
- B = formation volume factor (=1.0 for single-phase water reservoir)
- μ = fluid viscosity, cp
- h = thickness of formation tested, ft
- $t(\text{flow})$ = time of previous flow period
- dt = time elapsed since end of flow period

This equation is solved graphically by plotting $p(t)$ versus $\log \frac{t(\text{flow}) + dt}{dt}$, drawing the appropriate straight line through the data, and measuring the change in $p(t)$ on this line over one log cycle (m).

The above equation then reduces to:

$$k = \frac{162.6qB\mu}{mh}$$

The semi-log plot used in the Horner analysis can also be used to estimate the static formation pressure. The axis where $\log \frac{t(\text{flow}) + dt}{dt} = 1$ represents infinite recovery time, and the extrapolation of the pressure data to that axis should equal the static formation pressure.

4.6 TEST RESULTS

Testing began on September 4, 1983 and ended on September 23, 1983. A summary of the tests performed is provided in Table 5. The results of the tests are summarized in Table 6, and discussed below. The FFL analyses are not presented because first flows are typically dominated by drilling fluid unloading, and serve primarily to help clean the hole for the more important SFL. Flow tests and slug tests are similar, repetitive tests. The quality of the data should increase with each successive test, as the effects of loading the formation with drilling fluid are progressively lessened. For this reason, and because slug tests are performed until a greater degree of recovery is achieved than during flow tests, the slug tests provide the results most representative of actual reservoir properties of all the flow tests. Of the buildup period analyses, the SBU results are regarded as the more reliable because the SFL's better meet the theoretical assumptions of the analysis technique than the FFL's, and because the SBU's were continued until a greater degree of recovery was obtained than during the FBU's.

4.6.1 DST-4178: Hays Sandstone

The Hays sandstone was tested between the depths 4178.0 and 4298.6 feet below KB. Two flow tests (DST-4178/FFL and SFL), two buildup tests (FBU and SBU), and one slug test (SLUG) were performed (Figure 8). As shown in Table 6 and Figures 9 and 10, the analyses of the first and second buildups provided permeability estimates of 0.57 md and 0.71 md, respectively. These correspond to hydraulic conductivity values of 1.3×10^{-3} ft/day and 1.7×10^{-3} ft/day, respectively. The flow-period permeability estimates are slightly higher, with the second-flow data yielding a value of 1.7 md (Figure 11) and the slug-test data yielding a value of 0.94 md (Figure 12). These values correspond to hydraulic conductivity estimates of 3.9×10^{-3} ft/day and 2.2×10^{-3} ft/day, respectively.

The Horner plot of DST-4178/FBU (Figure 9) shows an early-time deviation below the Horner straight line, representing a slight positive skin, perhaps a mudcake, on the borehole wall. A similar effect was apparent

in early-time data from DST-4178/SBU not shown in Figure 10. When the FBU data are extrapolated to infinite recovery time, they yield a static formation pressure (p_{ext}) of 1883 psig (Figure 9). The very late-time SBU data show a slight deviation above the Horner straight line, probably reflecting the fact that the SFL was initiated before complete recovery from the FFL was achieved. This upward-deviation phenomenon reflects a superposition of buildups from separate flow events, and is typically distinguishable only when the buildup from the most recent flow becomes of very small magnitude. When the latest SBU data are extrapolated to infinite time, they provide a static formation pressure estimate of 1880 psig (Figure 10). With the transducer at a depth of 4165.4 feet below KB, and a fluid pressure gradient of 0.485 psi/ft (SG = 1.12; Table 7), these static formation pressure estimates correspond to a static fluid level (in an open borehole) 283 to 289 feet below KB, which is about the level of the Dewey Lake Redbeds.

4.6.2 DST-4138: Olds Sandstone

The Olds sandstone was tested between the depths 4138.5 and 4170.9 feet below KB. Two flow tests (DST-4138/FFL and SFL), two buildup tests (FBU and SBU), and one slug test (SLUG) were performed (Figure 13). The permeability values derived from the first and second buildups are 2.2×10^{-2} md (Figure 14) and 3.5×10^{-2} md (Figure 15), respectively. These correspond to hydraulic conductivity estimates of 4.5×10^{-5} ft/day and 7.2×10^{-5} ft/day, respectively. The flow-period permeability estimates are slightly higher, being 6.7×10^{-2} md for the second flow (Figure 16) and 8.2×10^{-2} md for the slug test (Figure 17). These values correspond to hydraulic conductivity estimates of 1.4×10^{-4} ft/day and 1.7×10^{-4} ft/day, respectively.

The Horner plots of DST-4138/FBU (Figure 14) and SBU (Figure 15) both show the very late time data deviating below the Horner straight line. Such deviations are typically the result of some type of negative reservoir boundary, such as a decrease in permeability at some distance from the well. The deviations could also represent depletion of a finite reservoir. Extrapolating the FBU and SBU very late time data to

infinite time provides static formation pressure estimates of 1934 psig (Figure 14) and 1910 psig (Figure 15), respectively. With the transducer at a depth of 4125.9 feet below KB, and a fluid pressure gradient of 0.503 psi/ft (SG = 1.16; Table 7), these pressures correspond to static fluid levels (in an open borehole) 281 feet and 329 feet below KB, respectively, which are in the middle of the Dewey Lake Redbeds.

4.6.3 DST-4100: Ramsey Sandstone

The Ramsey sandstone was tested between the depths 4100.5 and 4132.9 feet below KB. Two flow tests (DST-4100/FFL and SFL), two buildup tests (FBU and SBU) and one slug test (SLUG) were performed (Figure 18). The first and second buildups provided permeability estimates of 2.3×10^{-2} md (Figure 19) and 2.9×10^{-2} md (Figure 20), respectively. These values correspond to hydraulic conductivity estimates of 4.7×10^{-5} ft/day and 6.0×10^{-5} ft/day, respectively. Again, the flow-period permeability estimates are slightly higher, being 8.2×10^{-2} md for the second flow (Figure 21), and 8.7×10^{-2} md for the slug test (Figure 22). These values correspond to hydraulic conductivity estimates of 1.7×10^{-4} ft/day and 1.8×10^{-4} ft/day, respectively.

The Horner plots of DST-4100/FBU (Figure 19) and SBU (Figure 20) both show a very late time deviation of the data below the Horner straight line similar to that observed in DST-4138/FBU and SBU (Figures 14 and 15). Again, the deviations probably represent some type of negative reservoir boundary. Extrapolating the FBU and SBU very late time data to infinite time provides static formation pressure estimates of 1916 psig (Figure 19) and 1892 psig (Figure 20), respectively. With the transducer at a depth of 4087.9 feet below KB, and assuming a fluid pressure gradient similar to that of the Olds sandstone fluid (0.503 psi/ft), these pressures correspond to static fluid levels (in an open borehole) 279 feet and 326 feet below KB, respectively. These levels are virtually identical to those calculated for the Olds sandstone fluid.

4.6.4 DST-4044: Lamar Limestone

The Lamar limestone was tested between the depths 4044.2 and 4097.4 feet below KB. Because of the extremely low magnitude response of the unit, only a single flow (FFL) and buildup (FBU) cycle was performed (Figure 23). As shown on Figure 24, the buildup response in the Lamar was slow and prolonged. The permeability estimated from the buildup data is 6×10^{-4} md (0.6 μ d) (Figure 25). This corresponds to a hydraulic conductivity of 1×10^{-6} ft/day. Permeabilities of this order cannot be determined precisely with DST techniques, and thus, these values should be regarded as order-of-magnitude estimates.

The expanded-scale Horner plot of DST-4044/FBU (Figure 25) shows the data deviating below the Horner straight line at extremely late time, probably in response to some type of negative reservoir boundary. The extrapolation of these data to infinite time provides a static formation pressure estimate for the Lamar of 1886 psig. With the transducer at a depth of 4031.6 feet below KB, and assuming a fluid pressure gradient similar to that of the Olds sandstone fluid (0.503 psi/ft), this pressure corresponds to a static fluid level (in an open borehole) 282 feet below KB, virtually identical to that of the underlying sandstones.

4.6.5 DST-765: Salado Formation

The Salado Formation was tested between the depths 765.0 and 2725.4 feet below KB. Two flow tests (DST-765/FFL and SFL), two buildup tests (FBU and SBU), and one slug test (SLUG) were performed (Figure 26). The Salado did not respond sufficiently during the FFL, FBU, and SFL to provide analyzable data. The SBU and slug test were run for longer durations to provide better data. The SBU was marked by a sudden 14 psi jump after about 280 minutes of recovery (Figure 27). The pressure jump did not alter the pressure trend, but merely offset the trend by 14 psi. The pressures recorded above and below the tested interval showed no fluctuations at the time of the pressure jump. The phenomenon was not repeated, and its cause is unknown.

The expanded-scale Horner plot of DST-765/SBU (Figure 28) shows a steadily steepening curve. Using the slope of the latest data, the permeability was calculated to be about 9×10^{-6} md, corresponding to a hydraulic conductivity of about 2×10^{-8} ft/day. The slug test data do not fit a type curve very well, probably due in part to the fact that the pressure was still recovering from the previous flow tests when the slug test was initiated. The best fit obtained (Figure 29) provided a value of permeability of 8×10^{-5} md (80 nd). This value corresponds to a hydraulic conductivity of about 2×10^{-7} ft/day. Neither of the above test results should be considered anything other than order-of-magnitude approximations. At the conclusion of the slug test after about 25 hours of flow, the Salado was producing about 0.005 gpm under a pressure differential estimated to be greater than 200 psi.

As stated above, the Horner plot of DST-765/SBU (Figure 28) shows a steadily steepening curve. If the latest data are extrapolated to infinite time, they provide a static formation pressure estimate of about 390 psig. With the transducer at a depth of 752.4 feet below KB, and assuming a fluid pressure gradient similar to that of NaCl-saturated brine (0.52 psi/ft; SG = 1.2), this pressure corresponds to a static fluid level (in an open borehole) about 2 feet below KB (or 6 feet above the ground surface). The validity of the pressure extrapolation is questionable, and thus the static fluid level estimate is unreliable.

4.7 HYDROGEOCHEMICAL SAMPLING

One of the major objectives of the Cabin Baby testing program was to obtain reliable samples of the native Bell Canyon Formation fluids. These samples were to provide information on the fluid properties affecting flow, such as specific gravity/density and viscosity, as well as data on the major and minor element chemistries of the fluids. Coring and conditioning boreholes, however, introduces foreign fluids into the formations. To provide a means of differentiating between recently introduced fluids and the native formation fluids, an inert tracer was added to the drilling fluid prior to reaming and conditioning the hole. The tracer used was sodium thiocyanate (NaSCN), selected

because it is non-reactive and easily detected by colorimetric methods down to a concentration of less than one milligram per liter (mg/l). About 60-65 pounds of crystalline sodium thiocyanate were added to the drilling fluid, creating an initial thiocyanate (SCN^-) concentration of about 125 mg/l. Additional brine was added to the mud pits during reaming, and the SCN^- concentration when reaming was completed was about 80 mg/l.

At the conclusion of the slug tests in the Hays, Olds, and Ramsey units, and at the conclusion of all testing, a swabbing procedure was initiated to remove the drilling fluid left in the test interval and try to bring "fresh" formation fluid into the borehole. (The permeabilities of the Lamar limestone and Salado Formation are too low to make fluid sampling practical.) After initially swabbing as much fluid as possible out of the tubing, the fluid level was allowed to recover, typically for one to several hours, before swabbing again. This procedure was continued for a minimum of thirty-six hours, allowing about three to twelve times the test interval volume to be removed before collecting the final samples. The thiocyanate concentration in the fluid removed was monitored during swabbing, and provided an indication of the effectiveness of the cleaning procedure.

To lessen metals contamination of the samples, the tubing was thoroughly cleaned with detergent and hot water prior to its introduction into the hole. Additionally, a teflon-based pipe dope was used to lubricate all connections. Some metals contamination from the DST tool and tubing, however, was unavoidable.

Final fluid samples were collected in plastic bottles from the swabbing discharge line at the surface. Samples for major ion analyses were left unfiltered and untreated. Samples for metals analyses were filtered through a 0.45-micron filter, using either a pressurized nitrogen apparatus or a vacuum pump, and preserved with nitric acid at a pH of less than two. Field measurements performed included temperature, specific conductance, pH, and SCN^- concentration (Table 7). All samples were

stored in a refrigerator at the site prior to shipment to D'Appolonia Laboratories, Export, Pennsylvania, in sealed ice chests maintained at about 4°C. Preservation and shipment procedures were in accordance with recommendations of the U.S. EPA (1979) and APHA (1980).

4.7.1 Hays Sandstone Fluid Sampling

At the conclusion of DST-4178/SLUG, swabbing was begun to try to remove all traces of drilling fluid from the Hays sandstone test interval. A total of 34 swabs were pulled over a period of about 35 hours. About 6400 gallons of fluid were removed, representing 12 times the volume of the test interval. The thiocyanate (SCN^-) concentration in the fluid was measured colorimetrically about every other swab. The SCN^- concentration dropped from about 46 mg/l, measured after about 1.7 test-interval volumes were removed, to about two mg/l in the final sample sent to the laboratory, which was collected after about 12 test-interval volumes were removed (Table 7; Figure 30). The SCN^- concentration appeared to stabilize between about one and two mg/l after about 9.5 test-interval volumes had been removed. After 12 test-interval volumes had been removed and the SCN^- concentration had remained relatively stable, fluid samples were collected for laboratory analysis and swabbing was discontinued.

The analyses of the Hays sandstone fluid samples are summarized in Table 7. Based on the SCN^- concentration, the fluid samples appear to be contaminated with about two percent drilling fluid. The Hays fluid is a sodium-calcium chloride brine, with a total dissolved solids (TDS) concentration of about 191,000 mg/l. The fluid is neutral, having a pH of 7.0, and has a specific conductance of about 320,000 $\mu\text{mhos/cm}$. The two properties most important from a hydraulics standpoint are specific gravity and viscosity. These parameters have values of 1.12 and 1.30 cp, respectively.

4.7.2 Olds Sandstone Fluid Sampling

Following DST-4138/SLUG, the Olds sandstone test interval was cleaned by swabbing. Due to the low permeability and production rate of the Olds

sandstone, swabbing until the SCN^- concentration dropped to one to two mg/l was not practical. Four swabs were pulled over a period of about 36 hours. The total fluid volume removed was about 550 gallons, representing about 3.7 times the volume of the test interval. The fluid sample collected at the end of the fourth swab had a SCN^- concentration of about 16 mg/l (Table 7), indicating drilling fluid contamination of about twenty percent.

The Olds sandstone fluid is a sodium chloride brine, with a pH of about 7.3, a TDS of about 263,000 mg/l, and a specific conductance of about 430,000 $\mu\text{mhos/cm}$ (Table 7). Its specific gravity is about 1.16 and its viscosity is about 1.54 cp. Greater drilling fluid contamination is likely the cause, at least in part, of the Olds samples' ionic concentrations, specific gravity, and viscosity being greater than those of the Hays sandstone fluid.

4.7.3 Ramsey Sandstone Fluid Sampling

Following DST-4100/SLUG, an attempt was made to swab the Ramsey sandstone test interval and collect a fluid sample. At the end of the third swab, the swabbing cable parted and the swabbing assembly dropped through the dry tubing, damaging the seat nipple and ball bar sleeve on the DST tool. When the ball bar sleeve was damaged, drilling fluid in the borehole annulus above the test interval entered the tubing. At that point, the entire DST assembly had to be tripped out of the hole and repaired.

The three swabs successfully pulled produced a total of about 285 gallons, or about 1.8 test-interval volumes, over a period of about ten hours. The SCN^- concentration at the end of the third swab was about 29 mg/l.

The hydraulic properties of the Ramsey sandstone are very similar to those of the Olds sandstone (Table 6). Because of the difficulties encountered in trying to obtain a clean sample of the Olds sandstone fluid, and because of the time and expense required to go back into the

hole, restraddle the Ramsey, and start swabbing all over again, the decision was made to abandon the Ramsey sampling attempt, and proceed with the next DST.

4.7.4 Bell Canyon Fluid Sampling

After the final DST, a bridge plug (PIP) was set at 4038.9 feet below KB at the base of the Castile Formation in Anhydrite I. The drill tubing was left attached to the PIP and open to the interval below, forming an observation well completed through that portion of the Bell Canyon Formation penetrated by Cabin Baby-1 (Figure 3). Swabbing was initiated to remove the drilling fluid from the hole, so that the fluid level in the tubing would be an accurate representation of the hydraulic head of the upper Bell Canyon. A sample was collected on the fifth swab for specific gravity and viscosity determinations for the drilling fluid (Table 7). The SCN^- concentration on the eleventh swab was about 26 mg/l. On the twelfth swab, the swabbing cable parted and the swabbing assembly passed through the PIP and went to the bottom of the hole, where it remains. To that point, about 1800 gallons, representing about 1.5 times the volume of the test interval, had been swabbed over a period of about 16 hours.

The PIP and tubing were removed from the hole, repaired, and reset at 4040.8 feet below KB. Swabbing recommenced, and continued for about 38 hours. Twenty-six swabs were pulled, producing a total of about 4450 gallons, or about 3.8 times the volume of the isolated portion of the hole. The SCN^- concentration was monitored closely during swabbing, and appeared to stabilize around two mg/l after the twenty-second swab. A sample was collected on the twenty-fourth swab for specific gravity and viscosity determinations, and a full set of samples was collected on the final swab for major and minor element chemistry and fluid properties determinations (Table 7).

The major and minor element chemistries of the final sample are very similar to those of the Hays sandstone fluid sample (Table 7). This is to be expected as the Hays sandstone is the most permeable Bell Canyon

unit in Cabin Baby-1, and must have been the source of the majority of the fluid produced during swabbing. Based on the final SCN^- concentration of about two to four mg/l, the well is contaminated with less than five percent drilling fluid.

4.8 PRESENT WELL CONDITION

After the Bell Canyon portion of Cabin Baby-1 was cleaned by swabbing, a wellhead assembly was attached to the tubing at the ground surface and the hole was left as an upper Bell Canyon observation well (Figure 3). The annulus around the tubing was filled with drilling fluid to the surface. The fluid level in the tubing will be monitored by SNL and/or USGS. As the lower portion of the well is still contaminated slightly by drilling fluid, which has a higher specific gravity than the formation fluids, the fluid level in the tubing will be slightly lower than it would be with no contamination. On December 13, 1983, the fluid level in the tubing was about 310 feet below the ground surface.

REFERENCES

- American Public Health Association, 1980, Standard Methods for the Examination of Water, 15th edition, APHA, Washington, D.C.
- Cooper, H. H., J. D. Bredehoeft, and I. S. Papadopoulos, 1967, "Response of a Finite-Diameter Well to an Instantaneous Charge of Water", Water Resources Research, V. 3, No. 1, pp. 263-269.
- Freeze, R. A. and J. A. Cherry, 1979, Groundwater, Prentice-Hall, Inc., Englewood Cliffs, NJ, 604 pp.
- Goddard, E. N., chm., et al., 1948, Rock Color Chart, Washington, National Research Council (reprinted by Geological Society of America, 1975).
- Grace, M. P., 1974a, "Application for Permit to Drill, Deepen, or Plug Back," Form 9-331C, U.S. Department of the Interior, Geological Survey.
- Grace, M. P., 1974b, "Well Location and Acreage Dedication Plat," Form C-102, New Mexico Oil Conservation Commission.
- Grace, M. P., 1974c, "Sundry Notices and Reports on Wells," Form 9-331, U.S. Department of the Interior, Geological Survey.
- Grace, M. P., 1975, "Well Completion or Recompletion Report and Log," Form 9-330, U.S. Department of the Interior, Geological Survey.
- Horner, D. R., 1951, "Pressure Buildup in Wells," Proc. Third World Pet. Cong., The Hague, Sec. II, pp. 503-523. Also Reprint Series, No. 9-Pressure Analysis Methods, Soc. Pet. Engr., AIME, Dallas, TX, 1967, pp. 45-50.
- Powers, D. W., S. J. Lambert, S. E. Shaffer, L. R. Hill, and W. D. Weart, eds., 1978, Geological Characterization Report, Waste Isolation Pilot Plant (WIPP) Site, Southeastern New Mexico, SAND78-1596, Vol. I and II.
- Ramey, H. J., R. G. Agarwal, and I. Martin, 1975, "Analysis of 'Slug Test' or DST Flow Period Data", Jour. Can. Pet. Tech., Vol. 14, No. 3, pp. 37-47.
- Sandia National Laboratories and D'Appolonia Consulting Engineers, 1982, Basic Data Report for Drillhole AEC-7 (Waste Isolation Pilot Plant-WIPP), SAND79-0268, Sandia National Laboratories, Albuquerque, NM.
- Sandia National Laboratories and D'Appolonia Consulting Engineers, 1983, Basic Data Report for Drillhole AEC-8 (Waste Isolation Pilot Plant-WIPP), SAND79-0269, Sandia National Laboratories, Albuquerque, NM.

WTSD-TME-020

Sandia National Laboratories and U.S. Geological Survey, 1983, Basic Data Report for Drillhole ERDA 10 (Waste Isolation Pilot Plant-WIPP), SAND79-0271, Sandia National Laboratories, Albuquerque, NM.

U.S. Department of Energy, 1983, Summary of the Results of the Evaluation of the WIPP Site and Preliminary Design Validation Program, WIPP-DOE-161, USDOE, Albuquerque, NM.

U.S. Environmental Protection Agency, 1979, Methods for Chemical Analysis of Water and Wastes, EPA-6004-79-020, Office of Research and Development, USEPA, Cincinnati, Ohio.

TABLES

TABLE 1
 ABRIDGED HISTORY OF BOREHOLE CABIN BABY-1

Location: Sec. 5 T23S R31E
 1980.0 feet from the north line
 1980.0 feet from the east line
 Eddy County, New Mexico

Elevation: GL (ground level) 3320 (approximate
 elevation)
 KB (kelly bushing) 3328 (1983)

Cabin Baby-1 was initially drilled in 1974 and 1975 as a wildcat hydrocarbon well. Cabin Baby-1 was reentered in 1983 to deepen and perform hydrologic testing in support of the site characterization activities for the WIPP. Datum for depth measurements given in Tables 2, 3, and 4, and Figures 4 and 5 is the kelly bushing (8.0 feet from ground level).

Field lithologic log prepared by: Dann Meyer (D'Appolonia Consulting Engineers, Inc.)

Geophysical logs recorded by: Dresser Atlas (1975, 1983)
 United States Geological Survey
 (1983)

Hydrologic testing equipment by: Lynes, Inc. (1983)

Mud analysis: Marquez Trucking (1983)

Directional survey by: Sperry-Sun, Inc. (1983)

Drilling contractor: Michael P. Grace (1974-1975)
 Salazar Bros., Inc. (1983)

Coring contractor: Christensen Diamond Products Co.

TABLE 1 (continued)

Drilling record: Commenced initial drilling May 31, 1974 and completed initial drilling February 7, 1975 at a depth of 4159.0 feet below KB. The 1983 reentry of Cabin Baby-1 commenced coring on August 17, 1983 and completed coring (deepening) on August 19, 1983 at a total depth of 4298.6 feet below KB.

Casing: 13-3/8" OD casing set and cemented from 650 feet to surface (1974).

Mud: Unknown (1974, 1975)
4159.0-4298.6 feet - brine, salt gel, chromate, caustic soda, starch, sodium thiocyanate tracer (1983)

CORE BIT RECORD

<u>MAKE</u>	<u>SIZE</u>	<u>CORE SIZE</u>	<u>DEPTH OUT</u>	<u>FEET DRILLED</u>	<u>ROTATING HOURS</u>
Christensen Diamond Products	7-27/32" OD	4.0"	4298.6'	139.6	9.25

REAMING RECORD

<u>MAKE</u>	<u>BIT SIZE</u>	<u>BIT TYPE</u>	<u>DEPTH OUT</u>	<u>FEET REAMED</u>	<u>ROTATING TIME</u>
GH Texas Reamer	9-7/8"	Tri-cone	4298.6	898.6	2 days not continuous

CORING SUMMARY

<u>Core No.</u>	<u>Drillers Depth Interval (feet)</u>	<u>RPM</u>	<u>Weight on Bit (x 1000 lbs.)</u>	<u>Circ. Pressure (PSI)</u>	<u>Core Interval</u>		<u>Percent Recovered</u>
					<u>Feet Cored</u>	<u>Feet Recovered</u>	
1	4159-4219	50-65	10-16	500	60	58.9	98
2	4219-4279	55-60	10-16	500	60	60	100
3	4279-4298.6	60	15-18	500	19.6	19.6	100

TABLE 2
STRATIGRAPHIC SUMMARY OF BOREHOLE CABIN BABY-1

<u>ROCK UNIT</u>	<u>DEPTH INTERVAL IN FEET^(1,2)</u> <u>(BELOW KELLY BUSHING)</u>
<u>Quaternary</u>	15.5
<u>Triassic</u>	
Santa Rosa Sandstone	15.5 - 142.8
<u>Permian</u>	
Dewey Lake Redbeds	142.8 - 362.9
Rustler Formation	362.9 - 653.0
Magenta Dolomite member	375.0 - 414.1
Culebra Dolomite member	469.0 - 487.2
Salado Formation	653.0 - 2703.5
Upper member	653.0 - 1182.0
MB 101 ⁽³⁾	781.3
MB 102	818.0
MB 103	845.0 - 851.0
MB 105	884.2
MB 106	922.1
MB 107	946.8
MB 108	962.1
MB 109	977.0 - 993.9
MB 111	1036.9
MB 112	1065.8
MB 113	1097.0
MB 114	1117.1
MB 115	1157.1
MB 116	1169.8
McNutt member	1182.0 - 1585.1
MB 117	1251.0
MB 118	1277.6
MB 119	1299.9
MB 120	1328.9

TABLE 2 (Continued)

<u>ROCK UNIT</u>	<u>DEPTH INTERVAL IN FEET^(1,2)</u> <u>(BELOW KELLY BUSHING)</u>
MB 121	1346.1
MB 122	1353.2
Union Anhydrite	1381.8 - 1395.2
MB 123	1454.5 - 1463.1
MB 124	1470.0 - 1481.0
MB 126	1585.1
Lower member	1585.1 - 2703.5
MB 127	1610.2
MB 128	1621.8
MB 129	1650.1
MB 130	1663.2
MB 131	1732.9
MB 132	1763.7
MB 133	1784.2
MB 134	1837.7 - 1848.9
MB 135	1871.9
MB 136	1905.2 - 1912.0
MB 137	1930.5
MB 138	1990.4
MB 139	2040.7
MB 140	2104.0 - 2110.6
MB 141	2188.8 - 2196.9
MB 142	2239.8 - 2259.0
MB 143	2314.1 - 2321.0
MB 144	2356.0 - 2370.0
Cowden Anhydrite	2407.7 - 2434.7
Castile Formation	2703.5 - 4045.0
Anhydrite III	2703.5 - 3154.8
Halite II	3154.8 - 3373.1
Anhydrite II	3373.1 - 3480.0

TABLE 1 (continued)

ABRIDGED HISTORY OF BOREHOLE CABIN BABY-1

Type Log	Date	Run No.	Feet Logged From	To
<u>Dresser Atlas Logs</u> ⁽¹⁾				
Acoustilog	2-8-75	1	2900	4140
Gamma Ray	2-8-75	1	-0-	4140
Micro Laterolog	2-8-75	1	3930	4135
Laterolog	2-8-75	1	3930	4133
<u>Dresser Atlas Logs</u> ⁽²⁾				
4-Arm Caliper	8-16-83	1	660	4097
Gamma Ray	8-16-83	2	2100	4097
Compensated Neutron	8-16-83	2	2100	4097
Single-Arm Caliper	8-19-83	3	3800	4288
Compensated Neutron	8-19-83	3	3800	4288
Gamma Ray	8-19-83	3	3800	4288
Dual Laterolog	8-29-83	4	3800	4289
Micro Laterolog	8-29-83	4	3800	4289
Gamma Ray	8-29-83	4	3800	4289
<u>USGS Logs</u> ⁽²⁾				
3-Arm Caliper	8-28-83	1	390	4290
Gamma Ray	8-28-83	1	-0-	4290
Neutron Density	8-28-83	2	660	4290
Neutron Porosity	8-29-83	3	-0-	4303
Acoustic Televiewer	8-29-83	4	660	4298
<u>Sperry-Sun, Inc.</u> ⁽²⁾				
Directional Survey	9-24-83	1	-0-	4200

(1) Depths measured from ground surface.

(2) Depths measured from kelly bushing.

TABLE 2 (Continued)

<u>ROCK UNIT</u>	<u>DEPTH INTERVAL IN FEET^(1,2)</u> <u>(BELOW KELLY BUSHING)</u>
Halite I	3480.0 - 3810.2
Anhydrite I	3810.2 - 4045.0
Bell Canyon Formation	4045.0 - TD
Lamar limestone	4045.0 - 4086.0
Ramsey sandstone	4086.0 - 4132.0
Ford shale	4132.0 - 4140.0
Olds sandstone	4140.0 - 4171.0
Hays sandstone	4171.0 - 4298.6 (TD)

NOTE: Because the hole is cased above 660 feet, the location of geologic contacts and marker beds above this depth are uncertain.

FOOTNOTES:

- (1) Depth is base of unit when single number is given.
 (2) Depths to unit picks were based on geophysical log signatures.
 (3) MB = Marker Bed

TABLE 3
LITHOLOGIC LOG OF DEEPENED PORTION OF CABIN BABY-1

[Depths reported are measured from kelly bushing and are corrected to Dresser Atlas geophysical log depths. Color designations are from the Geological Society of America Rock Color Chart (Goddard et al., 1948).]

<u>LITHOLOGIC DESCRIPTION</u>	<u>DEPTH INTERVAL (IN FEET)</u>
Siltstone, medium-gray (N5) to medium-dark-gray (N4); very fine grained sand, calcareous, carbonaceous; contains black (N1), shaley, discontinuous and continuous partings and laminae; mostly unbedded; laminae usually aligned horizontally (i.e., perpendicular to core axis); concentration of black laminae and blebs from 4159.5 to 4161.6 feet; large bleb, possible fossil imprint, carbonaceous at 4162.6 feet (similar form occurs several times in core); fossiliferous zone, shell fragments, carbonaceous imprints from 4165.3 to 4165.7 feet; fossil imprint (similar to 4162.6 feet) at 4166.3 feet; concentration of carbonaceous partings/laminae and blebs, mostly aligned horizontally with large fossil imprint (similar to 4162.6 feet) from 4166.9 to 4171.1 feet; pyritized blebs at 4172.6 and 4173.6 feet; fine, thin (<0.1 inch), discontinuous, carbonaceous laminae (probably depositional feature, possibly bioturbated) from 4177.3 to 4178.9 feet; large laminated clast inclusion, gray siltstone with black laminae from 4179.8 to 4179.9 feet; black carbonaceous laminae and fossils (decreasing downward) from 4179.9 to 4182.0 feet	4159.0 - 4182.0
Siltstone, medium-gray (N5) to medium-dark-gray (N4); very fine grained sand, calcareous, little to no carbonaceous material; small (~0.25 inch) calcite-filled vug at 4190.2 feet; discontinuous, black (N1) shaley or carbonaceous laminae (<0.1 inch) at 4197.6 feet; concentrations of carbonaceous blebs or laminae from 4198.5 to 4198.9 feet; short, discontinuous, black, carbonaceous laminae, aligned horizontally (i.e., perpendicular to core axis) at 4199.4 feet; concentration of black, short, discontinuous laminae with small clast (0.25 inch) of underlying siltstone at 4203.2 feet	4182.0 - 4203.2
Siltstone, medium-gray (N5) to medium-light-gray (N6), calcareous, unbedded, massive; without any carbonaceous or shaley laminae; uniformly fine grained	4203.2 - 4208.8

TABLE 3 (Continued)

<u>LITHOLOGIC DESCRIPTION</u>	<u>DEPTH INTERVAL (IN FEET)</u>
Siltstone, medium-gray (N5) to medium-light-gray (N6), calcareous, unbedded, massive; with continuous, black, shaley or carbonaceous laminae, and evenly disseminated, discontinuous, short laminae from 4208.8 to 4209.0 feet; thick, (up to 0.75 inch), black, non-horizontal, anastomosing, continuous laminae or band from 4208.8 to 4213.9 feet; black, discontinuous carbonaceous laminae (<0.1 inch), at 4211.5 feet; prominent zone of carbonaceous laminae from 4213.5 to 4213.9 feet, discontinuous at 4213.5 feet, and continuous, horizontal at 4213.6 feet; decreasing concentration of laminae from 4213.6 to 4213.9 feet; contains laminated clast inclusion (>1.0 inch), possibly from underlying unit 4208.8 - 4213.8
Siltstone, medium-gray (N5), fine grained, unbedded, massive, calcareous (slow reaction with 10% HCl solution), carbonaceous laminae; tiny pyrite crystals from 4215.6 to 4215.7 feet; zone of concentrated, black, carbonaceous laminae, with rounded inclusion of non-laminated siltstone (from underlying unit) from 4217.7 to 4217.9 feet; continuous, black, shaley or carbonaceous layer (~0.02 feet thick) at 4220.6 feet; core fractured along lower contact of this layer at 4220.6 feet; lost core between 4217.9 and 4219.0 feet 4213.8 - 4220.6
Siltstone, medium-gray (N5), fine grained, unbedded, massive, calcareous (slow reaction with 10% HCl solution), with evenly disseminated, short, discontinuous shaley or carbonaceous laminae, black, usually aligned horizontally; possible fossiliferous zone (shell fragment) at 4222.2 feet; zone of continuous black, shaley or carbonaceous bands (up to 0.5 inch thick) with many thinner laminae from 4222.8 to 4223.0 feet; core breaks evenly along upper and lower contacts of banded zone; zone with shaley or carbonaceous blebs from 4223.0 to 4224.0 feet; continuous shaley or carbonaceous bands, dark-gray (N3) to black (N1), mostly thick (0.02 feet) bands with a few <0.1 inch laminae from 4224.8 to 4224.9 feet; core breaks evenly along upper contact of this banded zone 4220.6 - 4224.9
Siltstone, medium-gray (N4), fine grained, unbedded, massive, calcareous (slow reaction with 10% HCl solution); black band (0.02 feet thick), underlain by siltstone, fine grained (without sand component) laminated with black shaley or carbonaceous material, from 4227.77 to 4227.84 feet; intensely broken core from 4237.7 to 4238.0 feet 4224.9 - 4238.0

TABLE 3 (Continued)

<u>LITHOLOGIC DESCRIPTION</u>	<u>DEPTH INTERVAL (IN FEET)</u>
Siltstone, medium-gray (N4), fine grained, unbedded, massive, calcareous (slow reaction with 10% HCl solution), with shaley/carbonaceous laminae; zone of thin (<0.1 inch) black shaley/carbonaceous laminae from 4238.0 to 4238.1 feet; core breaks evenly along upper contact of this layer; zone of discontinuous, shaley/carbonaceous laminae and blebs (up to 0.75 inch), usually oriented subhorizontally (i.e., nearly perpendicular to core axis) from 4238.1 to 4242.9 feet; black, continuous band (0.01 feet), shaley or carbonaceous, containing many small (<1mm) rounded inclusions of gray siltstone from underlying unit at 4242.9 feet	4238.0 - 4242.9
Siltstone, medium-gray (N4), fine grained, unbedded, massive, calcareous (slow reaction with 10% HCl solution); black band (0.1 feet thick) contains concentration of black shaley carboniferous laminae at 4243.8 feet; core breaks evenly along upper contact of band at 4243.8 feet; zone of diffuse black laminae from 4243.9 feet to 4244.2 feet	4242.9 - 4250.9
Siltstone, medium-gray (N4), fine grained, unbedded, massive, calcareous (slow reaction with 10% HCl solution), with dispersed shaley/carbonaceous material; concentration of dispersed material is lower than in comparable overlying units; zone of concentration of thin (0.2 to <0.1 inch) continuous laminae of shaley/carbonaceous material from 4254.2 to 4254.3 feet	4250.8 - 4254.3
Siltstone, medium-gray (N4), fine grained, unbedded, massive, calcareous (slow reaction with 10% HCl solution).	4254.3 - 4266.0
Siltstone, medium-gray (N4), fine grained, unbedded, massive, calcareous (slow reaction with 10% HCl solution), with disseminated blebs and discontinuous laminae of black (N1), shaley/carbonaceous material; black, continuous bands (0.01 feet), with undulatory contacts and variable thickness at 4267.0 feet; black, continuous band, shaley/carbonaceous material at 4268.3 feet	4266.0 - 4268.3
Siltstone, medium-gray (N5), sandy, may be slightly clayey, calcareous, unbedded, massive; dark-gray (N3), continuous band (0.02 feet thick), shaley/carbonaceous, with irregular upper contact and even lower contact at 4270.0 feet; zone of black, shaley/carbonaceous laminae from 4272.2 to 4272.4 feet; laminae slightly undulatory in upper half, sandy at lower contact, core breaks evenly along upper contact at	

TABLE 3 (Continued)

<u>LITHOLOGIC DESCRIPTION</u>	<u>DEPTH INTERVAL (IN FEET)</u>
4272.2 feet; medium-gray (N5) band, shaley/carbonaceous material, with sand, continuous, regular, from 4274.0 to 4274.1 feet; zone of medium-dark-gray (N4) to dark-gray (N3) bands (0.05 to 0.1 feet), interfingering with host siltstone at 4277.0 feet; zone of concentration of black laminae, shaley/ carbonaceous, continuous, irregularly undulatory from 4278.6 to 4278.7 feet	4268.3 - 4279.8
Siltstone, medium-gray (N5), sandy, may be slightly clayey, calcareous, unbedded, massive; with black, shaley and/or carbonaceous laminae, blebs, and discontinuous, thin stringers; medium-dark-gray (N4) band, containing continuous laminae, and concentration of shaley/carbonaceous blebs and stringers from 4279.8 to 4279.9 feet; black, continuous laminae from 4280.9 to 4281.3 feet; black band, shaley/ carbonaceous, continuous, anastomosing, containing bands and rounded inclusions of host siltstone from 4281.7 to 4281.8 feet	4279.8 - 4283.3
Siltstone, medium-gray (N5), sandy, may be slightly clayey, calcareous, unbedded, massive; black, shaley/carbonaceous laminae are diffuse and occur in undulatory, en echelon, mostly subhorizontal bands; each lamina is composed of individual black particles; undulatory, diffuse banding decreases downward in unit; black band (0.02 to 0.03 feet thick), shaley/carbonaceous material at 4283.3 feet; zone of concentration of large (up to 0.75 inch), black, shaley/ carbonaceous clasts, aligned subhorizontally, from 4285.8 to 4286.0; clasts appear to have been broken up from a few larger clasts; zone of concentration of black laminae from 4286.0 to 4286.2 feet	4283.3 - 4286.2
Siltstone, medium-gray (N5), sandy, may be slightly clayey, calcareous, unbedded, massive	4286.2 - 4287.0
Siltstone, dark-gray (N3) to medium-dark-gray (N4), fine sand, shale, calcareous, with many black shaley/carbonaceous laminae and bands, increasing frequency downward; zone of high shaley/carbonaceous material, cross-laminated, evidence of redeposition of clasts, discontinuous and broken bands, microfaults and folding (deformation in semi-solid state) from 4289.3 to 4290.6 feet	4287.0 - 4290.6
Siltstone, medium-gray (N5), slightly sandy and clayey, calcareous, laminated with black shaley/carbonaceous material, discontinuous laminations and blebs; laminae are slightly irregular or deformed, undulatory, variable thickness	4290.6 - 4291.8

TABLE 3 (Continued)

<u>LITHOLOGIC DESCRIPTION</u>	<u>DEPTH INTERVAL (IN FEET)</u>
Shale and siltstone, banded; shale, grayish-black (N2) to black (N1); siltstone, medium-gray (N5) to medium-dark-gray (N4); laminated shale with siltstone with laminae/layers strongly deformed, and attitudes from 30° to parallel to core axis from 4292.3 to 4295.3 feet; shale very calcareous; siltstone with several black, shaley/carbonaceous bands composed of several diffuse laminae from 4295.3 to 4297.5 feet; bands are deformed, discontinuous, and some with attitudes 30-40° from horizontal; dark-gray (N3) to black (N1) band, with concentration of shaley/carbonaceous laminae, calcareous lenses (<1 inch) of shale and siltstone rimmed by thin black laminae, from 4297.5 to 4298.0 feet; siltstone, with disseminated black shaley/carbonaceous material from 4298.0 to 4298.6 feet	4291.8 - 4298.6

END OF CORE RUN AND DEEPENING

TABLE 4
CABIN BABY-1 SPERRY-SUN DIRECTIONAL SURVEY

BOREHOLE DEPTH (FEET) (1)	DIRECTION DEG MIN		ACTUAL VERTICAL ANGLE		DEPTH (FEET)	LATITUDE DEPARTURE (FEET)		
			DEG	MIN		NORTH-SOUTH	EAST-WEST	VECTOR SUM
0	N	0 0	E	0 0	0.00	0.00 N	0.00 E	0.00
100	N	5 12	E	0 22	100.00	0.32 N	0.03 E	0.16
200	N	32 48	W	0 35	200.00	1.08 N	0.23 W	0.79
300	N	40 36	W	0 44	299.99	2.00 N	0.93 W	1.89
400	N	46 54	W	1 19	399.97	3.27 N	2.18 W	3.64
500	N	53 36	W	1 15	499.95	4.70 N	3.90 W	5.86
600	N	54 24	W	2 12	599.90	6.46 N	6.34 W	8.87
700	N	58 42	W	2 10	699.83	8.56 N	9.51 W	12.68
800	N	42 30	W	2 28	799.75	11.14 N	12.59 W	16.67
900	N	27 54	W	3 53	899.59	15.72 N	15.63 W	21.76
1000	N	11 12	W	3 56	999.36	22.08 N	17.88 W	27.21
1100	N	11 12	W	3 44	1099.14	28.64 N	19.18 W	31.98
1200	N	7 12	W	3 19	1198.95	34.72 N	20.18 W	36.22
1300	N	9 12	W	3 14	1298.78	40.37 N	20.99 W	40.08
1400	N	18 6	W	3 1	1398.64	45.65 N	22.26 W	44.09
1500	N	29 48	W	3 7	1498.49	50.50 N	24.43 W	48.62
1600	N	48 54	W	3 11	1598.34	54.69 N	27.88 W	53.83
1700	N	58 12	W	3 4	1698.20	57.93 N	32.25 W	59.27
1800	N	69 12	W	3 23	1798.04	60.39 N	37.28 W	64.81
1900	N	77 54	W	3 44	1897.85	62.12 N	43.22 W	70.69
2000	S	86 0	W	3 15	1997.66	62.60 N	49.22 W	75.93
2100	S	80 6	W	3 23	2097.49	61.90 N	54.96 W	80.27
2200	S	70 24	W	3 11	2197.33	60.46 N	60.47 W	84.02
2300	S	63 12	W	3 34	2297.16	58.13 N	65.87 W	87.16
2400	S	76 6	W	3 56	2396.94	55.90 N	71.97 W	90.95
2500	N	87 0	W	4 8	2496.70	55.27 N	78.89 W	96.31
2600	N	72 54	W	4 34	2596.42	56.62 N	86.29 W	103.19
2700	N	57 54	W	5 11	2696.06	60.20 N	93.92 W	111.50
2800	N	22 24	W	2 31	2795.83	64.63 N	98.59 W	117.85
2900	N	41 48	E	1 59	2895.77	67.95 N	98.27 W	119.46
3000	S	76 18	E	1 45	2995.73	68.88 N	95.62 W	117.80
3100	S	27 6	E	1 33	3095.69	67.31 N	93.52 W	115.18
3200	S	18 6	W	1 44	3195.65	64.67 N	93.38 W	113.57
3300	S	74 36	W	1 44	3295.61	62.82 N	95.31 W	114.13
3400	N	68 54	W	1 57	3395.56	63.03 N	98.35 W	116.76
3500	N	46 0	W	1 41	3495.51	64.67 N	101.00 W	119.87
3600	N	39 0	W	1 1	3595.48	66.38 N	102.61 W	122.17
3850	N	26 54	W	0 39	3845.46	69.36 N	104.64 W	125.52
3900	N	28 24	W	0 41	3895.45	69.87 N	104.91 W	126.04
4000	N	32 54	W	0 49	3995.45	71.00 N	105.58 W	127.22
4100	N	46 30	W	1 7	4095.43	72.26 N	106.68 W	128.84
4200	N	42 36	W	1 5	4195.41	73.64 N	108.03 W	130.73

(1) Depths relative to kelly bushing.

TABLE 5
HYDROLOGIC TESTING ACTIVITY SUMMARY

ACTIVITY	DEPTH ⁽¹⁾ INTERVAL (ft)	UNIT NAME	TEST	TEST DATE	START TIME	END TIME	PRESSURE PRIOR TO TEST (psia)	START PRESSURE (psia)	END PRESSURE (psia)
DST-4178	4178.0-4298.6	Hays	FFL	9/04/83	14:40:40	14:46:10	1903.9	531.4	622.8
			FBU	9/04/83	14:46:10	15:09:19	----	622.8	1846.3
			SFL	9/04/83	15:09:19	15:35:04	1846.3	640.4	953.1
			SBU	9/04/83	15:35:04	18:02:28	----	953.1	1866.0
			SLUG	9/4-5/83	18:02:28	00:34:02	1866.0	446.9	1787.8
DST-4138	4138.5-4170.9	Olds	FFL	9/07/83	13:55:54	14:08:06	1939.0	217.5	224.2
			FBU	9/07/83	14:08:06	15:42:48	----	224.2	1869.7
			SFL	9/07/83	15:42:48	16:42:00	1869.7	228.7	255.7
			SBU	9/07/83	16:42:00	21:41:30	----	255.7	1864.5
			SLUG	9/7-10/83	21:41:30	01:15:46	1864.5	260.3	965.9
DST-4100	4100.5-4132.9	Ramsey	FFL	9/12/83	04:44:58	05:00:10	1918.5	45.2	55.0
			FBU	9/12/83	05:00:10	06:33:15	----	55.0	1819.1
			SFL	9/12/83	06:33:15	07:29:06	1819.1	61.2	87.8
			SBU	9/12/83	07:29:06	11:50:45	----	87.8	1825.0
			SLUG	9/12-14/83	11:50:45	13:00:00	1825.0	93.1	844.4
DST-4044	4044.2-4097.4	Lamar	FFL	9/16/83	22:54:53	23:09:56	1963.5	370.0	378.0
			FBU	9/16-19/83	23:09:56	13:20:02	----	378.0	1837.8
DST-765	765.0-2725.4	Salado	FFL	9/20/83	10:37:12	10:49:18	512.9	115.8	128.6
			FBU	9/20/83	10:49:18	12:02:48	----	128.6	164.5
			SFL	9/20/83	12:02:48	12:35:06	164.5	137.6	141.1
			SBU	9/20-22/83	12:35:06	14:10:03	----	141.1	325.1
			SLUG	9/22-23/83	14:18:00	15:45:01	325.1	120.0	168.1

(1) All depths are relative to kelly bushing

TABLE 6
SUMMARY OF DST RESULTS

TEST	DEPTH ⁽¹⁾ INTERVAL (ft)	UNIT NAME	ANALYTICAL METHOD	k (md)	K (ft/day)	P _{ext} (psia) ⁽²⁾	REMARKS
DST-4178/FBU /SFL /SBU /SLUG	4178.0-4298.6	Hays	Horner	0.57	1.3×10^{-3}	1894 ⁽³⁾	
			Slug	1.7	3.9×10^{-3}	NA	
			Horner	0.71	1.7×10^{-3}	1891 ⁽³⁾	
			Slug	0.94	2.2×10^{-3}	NA	
DST-4138/FBU /SFL /SBU /SLUG	4138.5-4170.9	Olds	Horner	2.2×10^{-2}	4.5×10^{-5}	1945 ⁽⁴⁾	
			Slug	6.7×10^{-2}	1.4×10^{-4}	NA	
			Horner	3.5×10^{-2}	7.2×10^{-5}	1921 ⁽⁴⁾	
			Slug	8.2×10^{-2}	1.7×10^{-4}	NA	
DST-4100/FBU /SFL /SBU /SLUG	4100.5-4132.9	Ramsey	Horner	2.3×10^{-2}	4.7×10^{-5}	1927 ⁽⁵⁾	
			Slug	8.2×10^{-2}	1.7×10^{-4}	NA	
			Horner	2.9×10^{-2}	6.0×10^{-5}	1903 ⁽⁵⁾	
			Slug	8.7×10^{-2}	1.8×10^{-4}	NA	
DST-4044/FBU	4044.2-4097.4	Lamar	Horner	6×10^{-4}	1×10^{-6}	1897 ⁽⁶⁾	
DST-765/SBU /SLUG	765.0-2725.4	Salado	Horner	9×10^{-6}	2×10^{-8}	402 ⁽⁷⁾	maximum k poor data fit to type curve
			Slug	8×10^{-5}	2×10^{-7}	NA	

(1) All depths are relative to kelly bushing

(2) $psig \approx psia - 10.6 \text{ psi}$

(3) Pressures measured at depth 4165.4 feet

(4) Pressures measured at depth 4125.9 feet

(5) Pressures measured at depth 4087.9 feet

(6) Pressures measured at depth 4031.6 feet

(7) Pressures measured at depth 752.4 feet

TABLE 7

CHEMICAL COMPOSITION OF FLUIDS
BELL CANYON FORMATION - CABIN BABY-1

SAMPLE: FIELD DETERMINATIONS:	UNITS	HAYS SANDSTONE	OLDS SANDSTONE	UPPER BELL CANYON		PIP-4039 ⁽⁸⁾ SWAB #5 ⁽⁹⁾
		DST-4178 ⁽¹⁾ SWAB #34 ⁽²⁾	DST-4138 ⁽³⁾ SWAB #4 ⁽⁴⁾	PIP-4041 ⁽⁵⁾ SWAB #24 ⁽⁶⁾	PIP-4041 ⁽⁵⁾ SWAB #26 ⁽⁷⁾	
Temperature	°C	32 ⁽¹⁰⁾	24 ⁽¹¹⁾	—	22	—
pH	Standard Units	6.5-7.0	6.5	—	6-7	—
Specific Conductance	µmhos/cm @25°C	—	320,000	—	370,000	—
Thiocyanate ⁽¹²⁾	mg/l	2.2	16	1.4	1.9	—
LABORATORY DETERMINATIONS:						
pH	Standard Units	7.00	7.35	—	6.62	—
Specific Conductance	µmhos/cm @25°C	320,000	430,000	360,000	330,000	610,000
Specific Gravity	—	1.120/1.134	1.160/1.177	1.117	1.128	1.255
Total Dissolved Solids ⁽¹³⁾	mg/l	191,000	263,000	—	188,000	—
Total Suspended Solids ⁽¹⁴⁾	mg/l	1,330	13,500	—	12,600	—
Viscosity	cp	1.300	1.538	1.457	1.498	2.673
Cations:						
Barium	mg/l	127	137	—	137	—
Calcium	mg/l	11,400	2,300	—	9,300	—
Cesium	mg/l	<2	<2	—	2	—
Lithium	mg/l	21	12	—	22	—
Magnesium	mg/l	2,300	3,400	—	2,300	—
Potassium	mg/l	1,400	5,300	—	1,500	—
Sodium	mg/l	62,000	98,000	—	60,000	—
Strontium	mg/l	255	33	—	200	—
Anions:						
Bicarbonate	mg/l	94	220	—	148	—
Bromide	mg/l	60	72	—	70	—
Chloride	mg/l	115,000	160,500	—	117,500	—
Fluoride	mg/l	0.3	0.3	—	0.3	—
Iodide	mg/l	2	2	—	2	—
Sulfate	mg/l	1375	3925	—	2525	—
Thiocyanate ⁽¹²⁾	mg/l	2.0	17	3.6	4.3	80
Nutrients:						
Ammonia (as Nitrogen)	mg/l	299	159	—	299	—
Nitrate (as Nitrogen)	mg/l	0.15	0.95	—	0.1	—
Phosphate (as Phosphorus)	mg/l	3.5	2.0	—	9.5	—
Other Elements:⁽¹⁵⁾						
Aluminum	mg/l	0.28	0.28	—	0.28	—
Boron	mg/l	53	42	—	48	—
Copper	mg/l	0.47	0.49	—	0.27	—
Iron	mg/l	36	3.69	—	41	—
Manganese	mg/l	4.9	4.0	—	5.1	—
Silicon (as SiO ₂)	mg/l	5.3	5.9	—	4.9	—
Zinc	mg/l	23	34	—	1.9	—

NOTES:

- (1) Test interval 4178.0-4298.6 feet below KB.
 - (2) Sample collected on 34th swab after ~6400 gallons (12 test-interval volumes) removed.
 - (3) Test interval 4138.5-4170.9 feet below KB.
 - (4) Sample collected on 4th swab after ~550 gallons (3.7 test-interval volumes) removed.
 - (5) Test interval 4040.8-4298.6 feet below KB.
 - (6) Sample collected on 24th swab after ~4220 gallons (3.6 test-interval volumes) removed.
 - (7) Sample collected on 26th swab after ~4450 gallons (3.8 test-interval volumes) removed.
 - (8) Test interval 4038.9-4298.6 feet below KB.
 - (9) Sample represents drilling fluid in borehole.
 - (10) Downhole temperature averaged 31°C during DST-4178.
 - (11) Downhole temperature averaged 31°C during DST-4138.
 - (12) Thiocyanate added as tracer to drilling fluid. Presence of thiocyanate in samples indicates contamination.
 - (13) Solids, residue on evaporation at 180°C, dissolved, gravimetric.
 - (14) Solids, residue at 105°C, suspended, gravimetric.
 - (15) Flow through drill tubing may have contaminated samples with metals.
- “—” = Parameter not analyzed.

FIGURES

B3U

DRAWN BY	L.O.G.	CHECKED BY	10/28/85	DRAWING NM-78-648-A155
	10-26-82	APPROVED BY	12/20/83	NUMBER

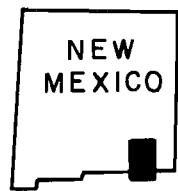
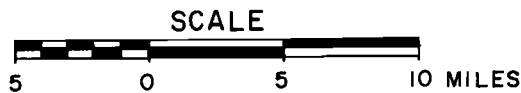
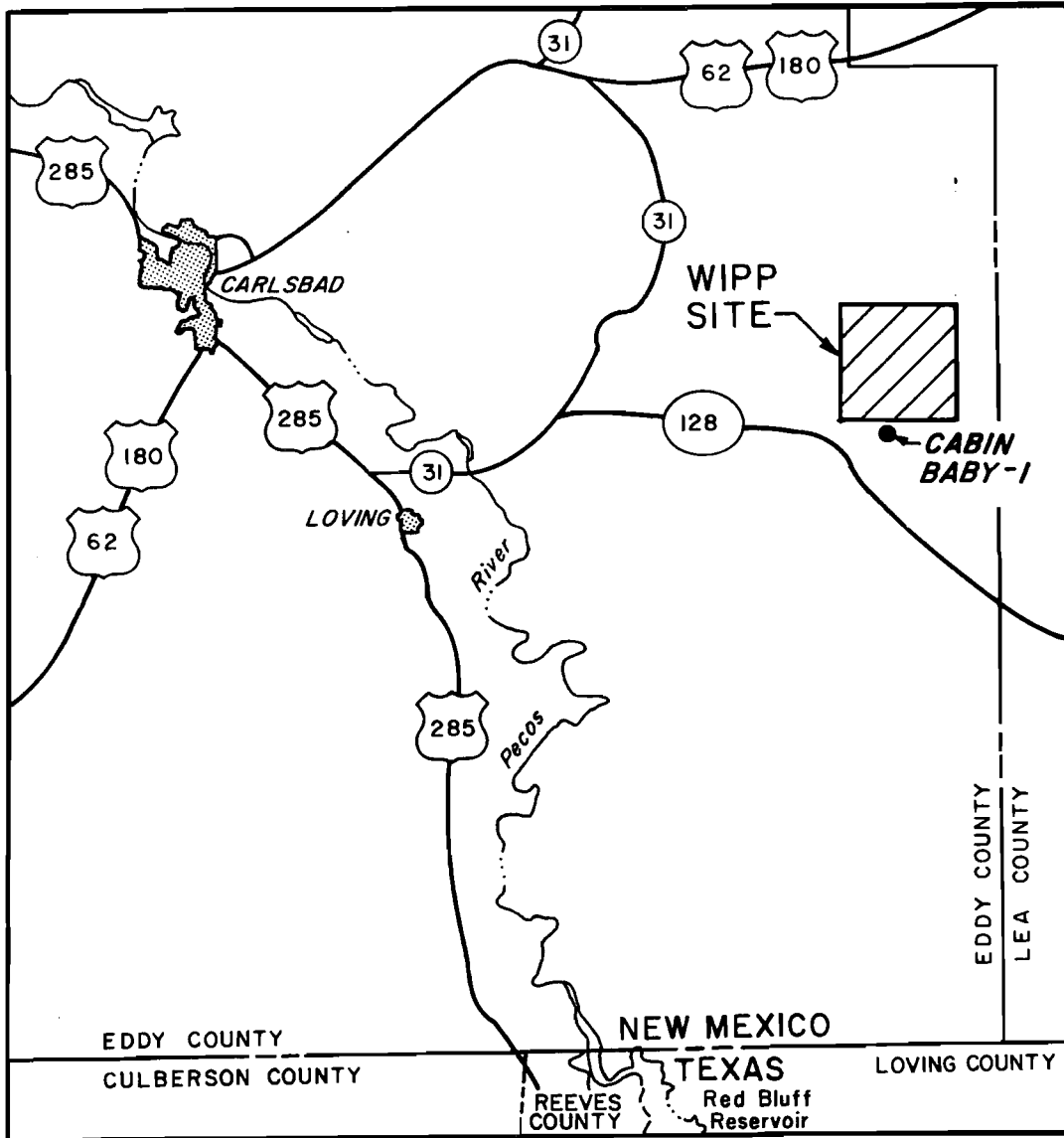

KEY MAP

FIGURE 1

LOCATION OF THE WIPP SITE AND BOREHOLE CABIN BABY-1

PREPARED FOR

WESTINGHOUSE ELECTRIC CORPORATION ALBUQUERQUE, NEW MEXICO

D'APPOLONIA

830

DRAWN BY
 L.O.G. 10-25-83
 CHECKED BY 9/14/83
 APPROVED BY 12/20/83
 DRAWING NM-78-648-A156
 NUMBER

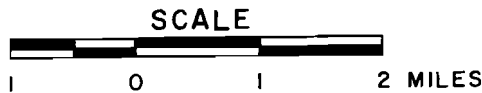
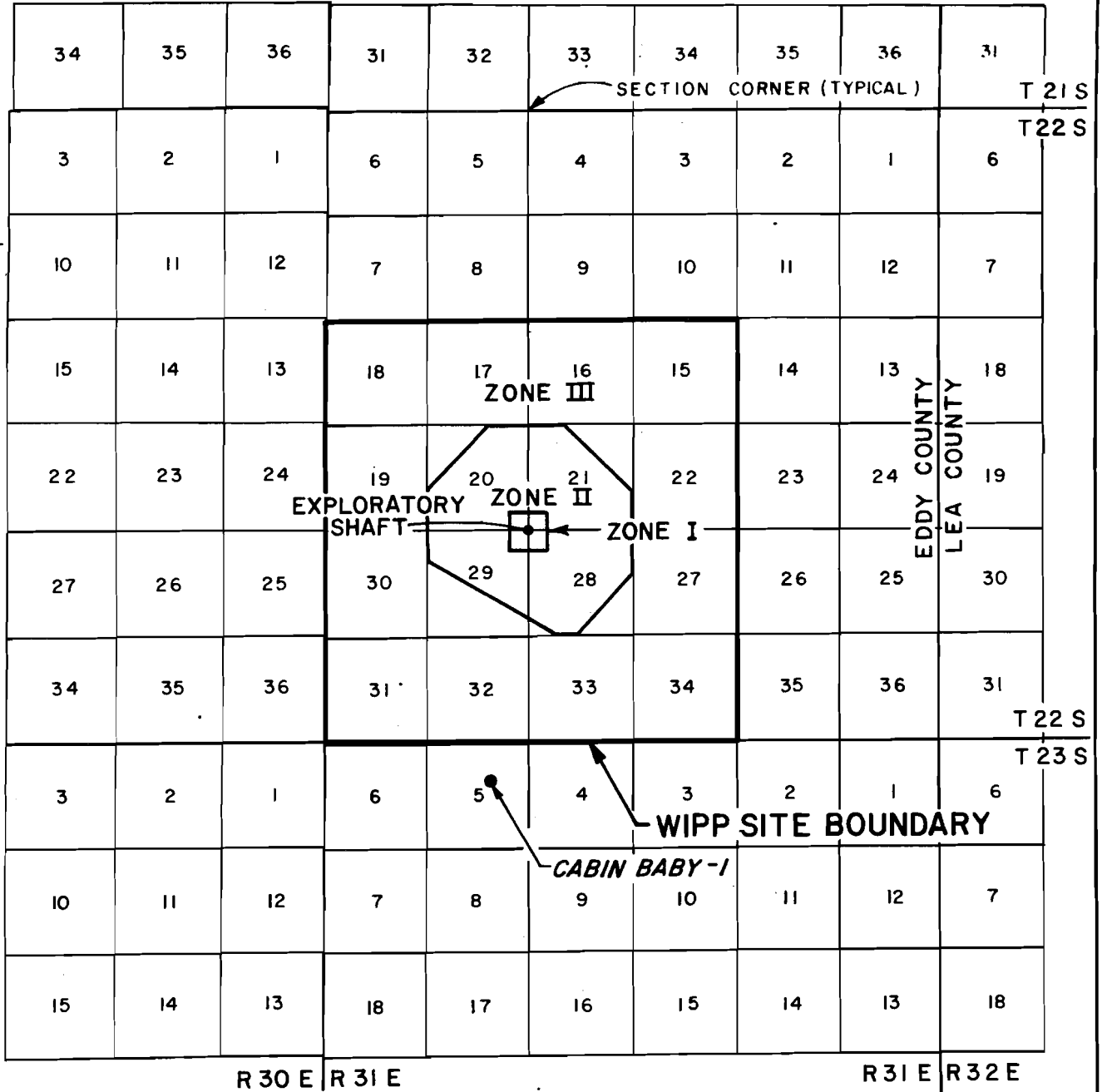
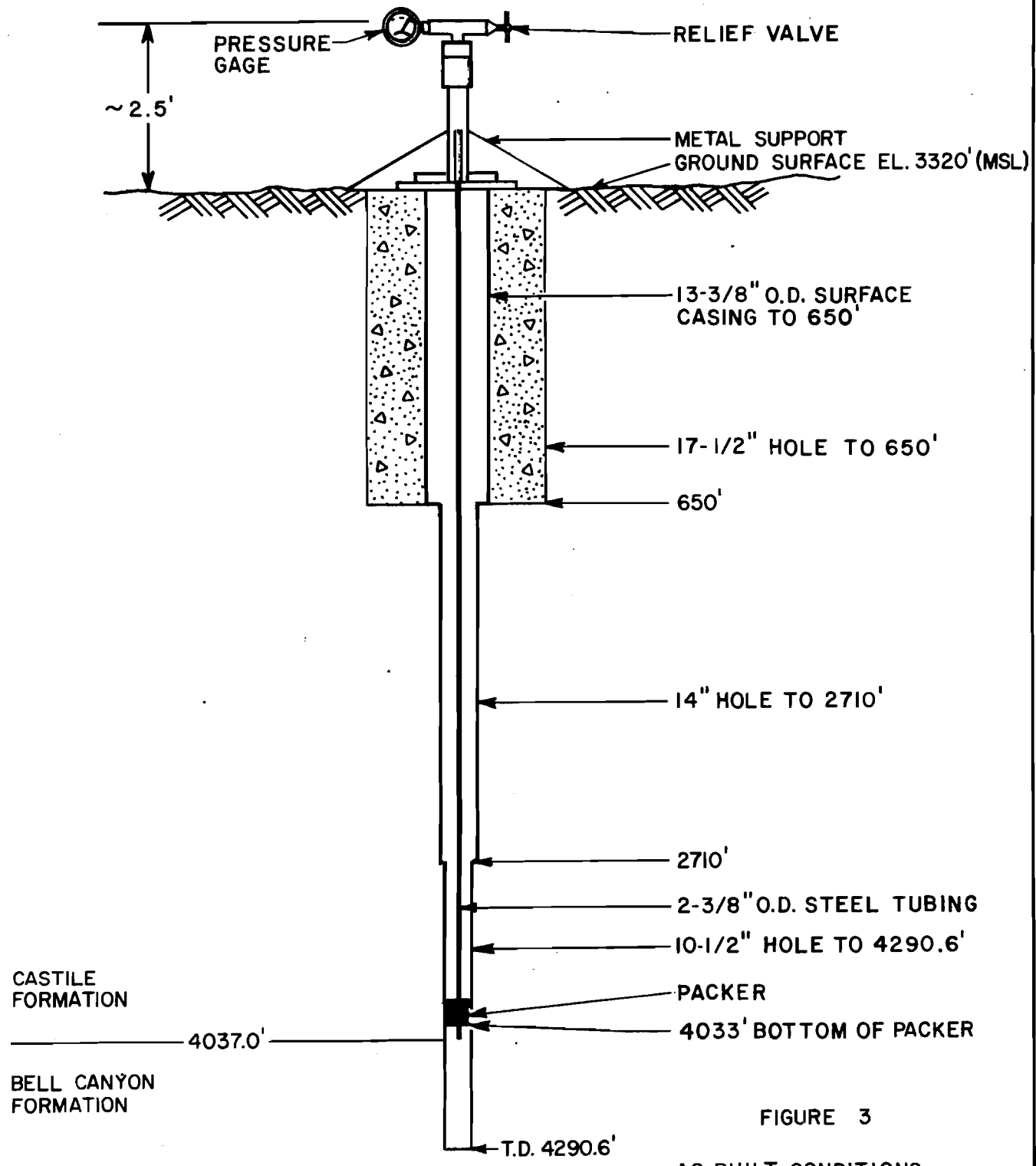

FIGURE 2
 PLAN OF THE WIPP SITE
 AND LOCATION OF BOREHOLE
 CABIN BABY-1
 PREPARED FOR
 WESTINGHOUSE ELECTRIC CORPORATION
 ALBUQUERQUE, NEW MEXICO

D'APPOLONIA

DRAWING NM-78-648-A157
 NUMBER
 11-9-83
 12/28/83
 CHECKED BY
 APPROVED BY
 L.O.G.
 11/3/83
 DRAWN BY



NOT TO SCALE

FIGURE 3
 AS-BUILT CONDITIONS
 AFTER DEEPENING BOREHOLE
 CABIN BABY - I

PREPARED FOR

WESTINGHOUSE ELECTRIC CORPORATION
 ALBUQUERQUE, NEW MEXICO

NOTES

1. DEPTHS MEASURED FROM GROUND LEVEL
2. HOLE DIAMETER BASED ON AVERAGES FROM CALIPER LOG.

D'APPOLONIA

FIGURE 4
GEOPHYSICAL AND LITHOLOGIC LOGS
FOR CABIN BABY-1

WTSD-TME-020

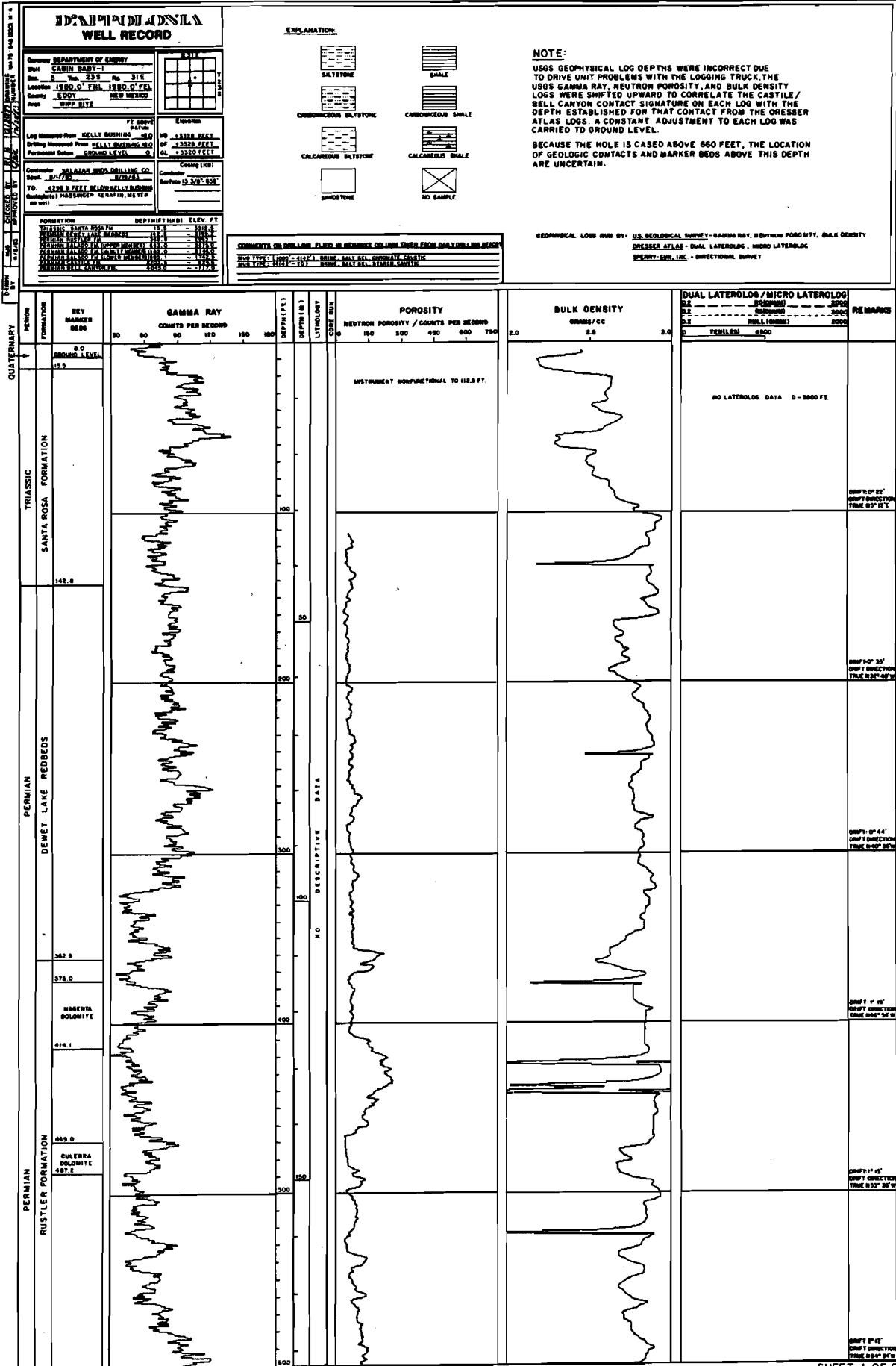

FIGURE 4 CABIN BABY-1

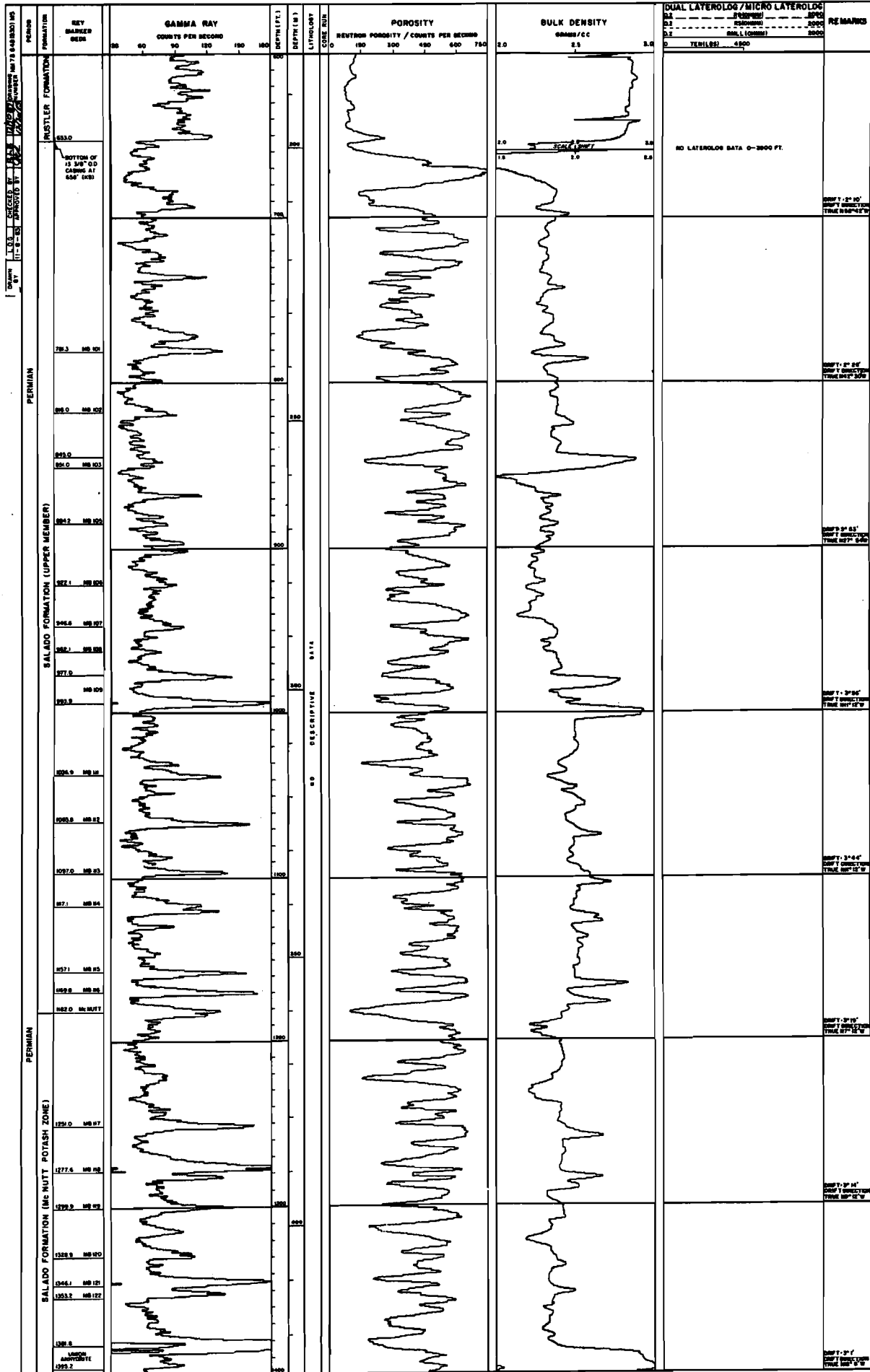

FIGURE 4 CABIN BABY-1

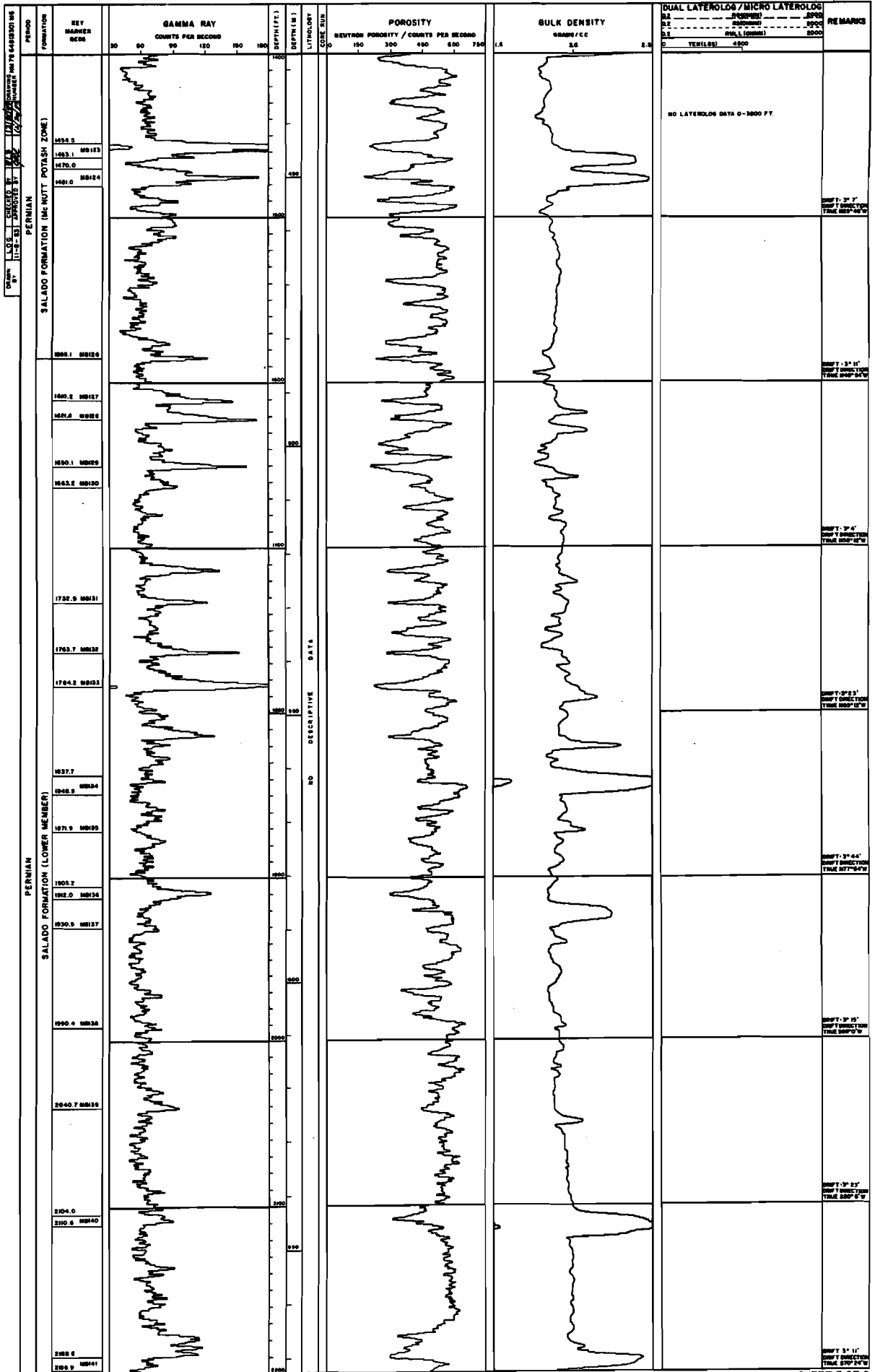

FIGURE 4 CABIN BABY-I

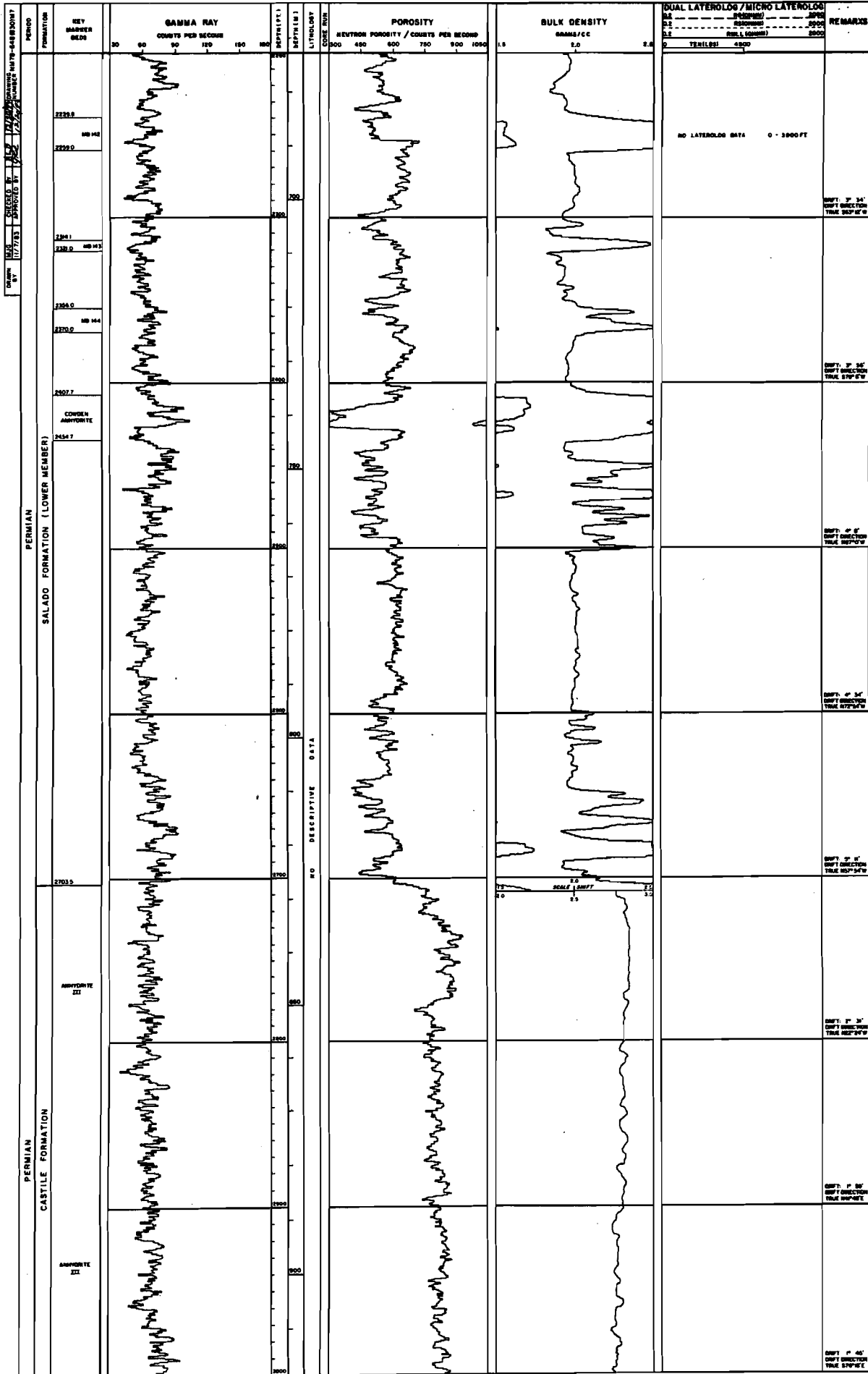

FIGURE 4 CABIN BABY-1

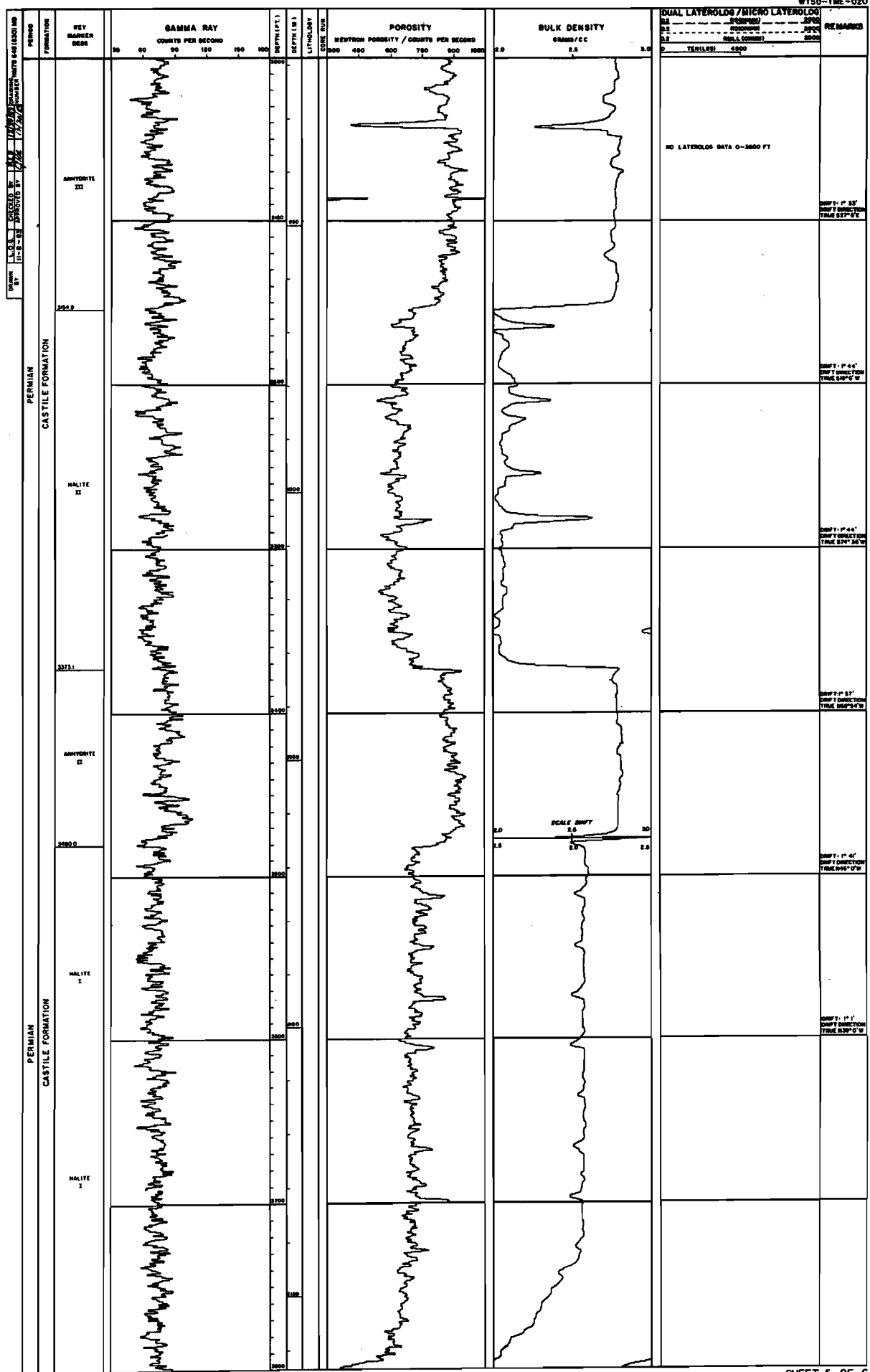

FIGURE 4 CABIN BABY-1

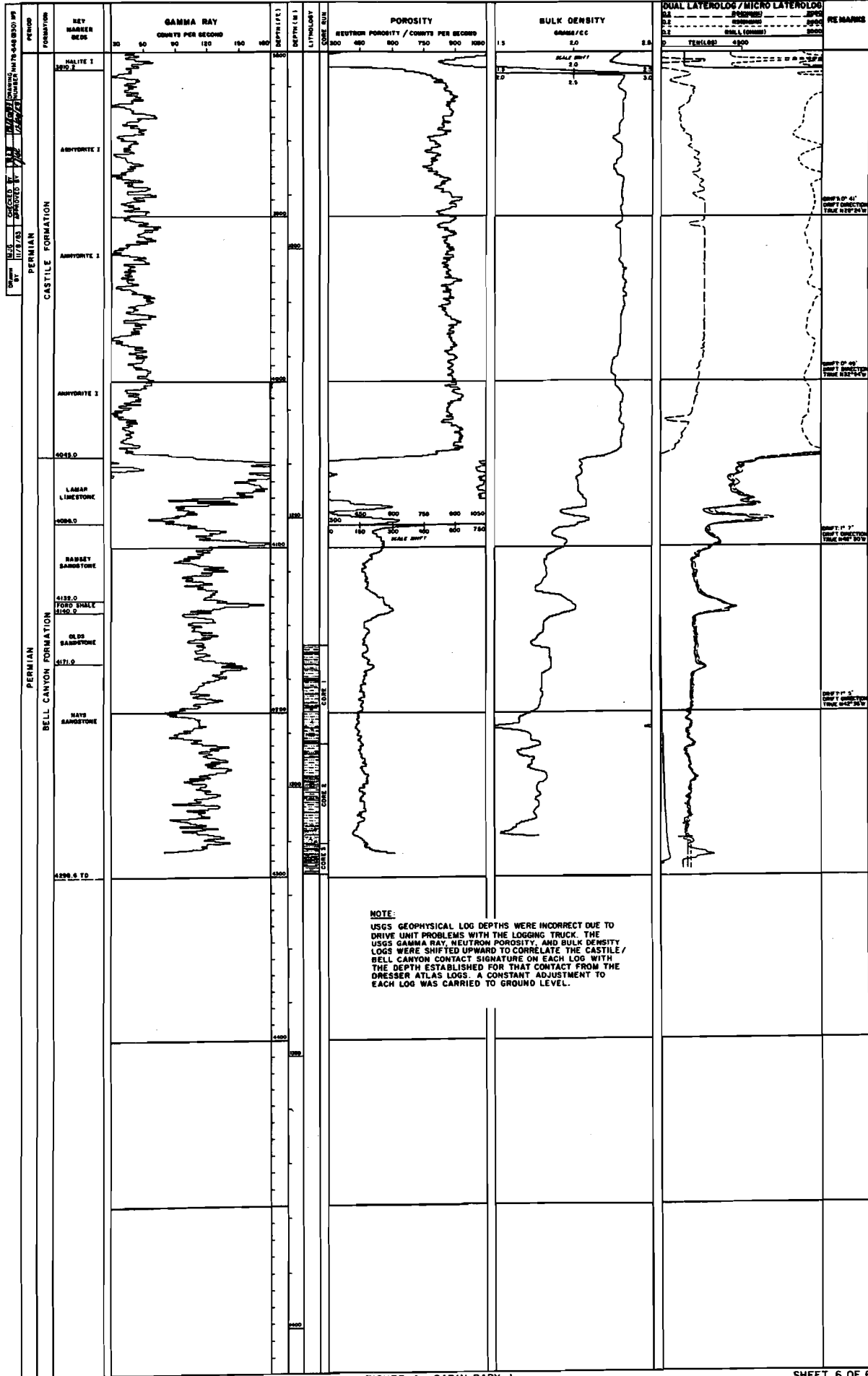

FIGURE 4 CABIN BABY-1

630

DRAWN BY	L.O.G.	CHECKED BY	11-9-83	DRAWING NUMBER	NM-78-648-A156
	11-2-83	APPROVED BY	12/20/83		

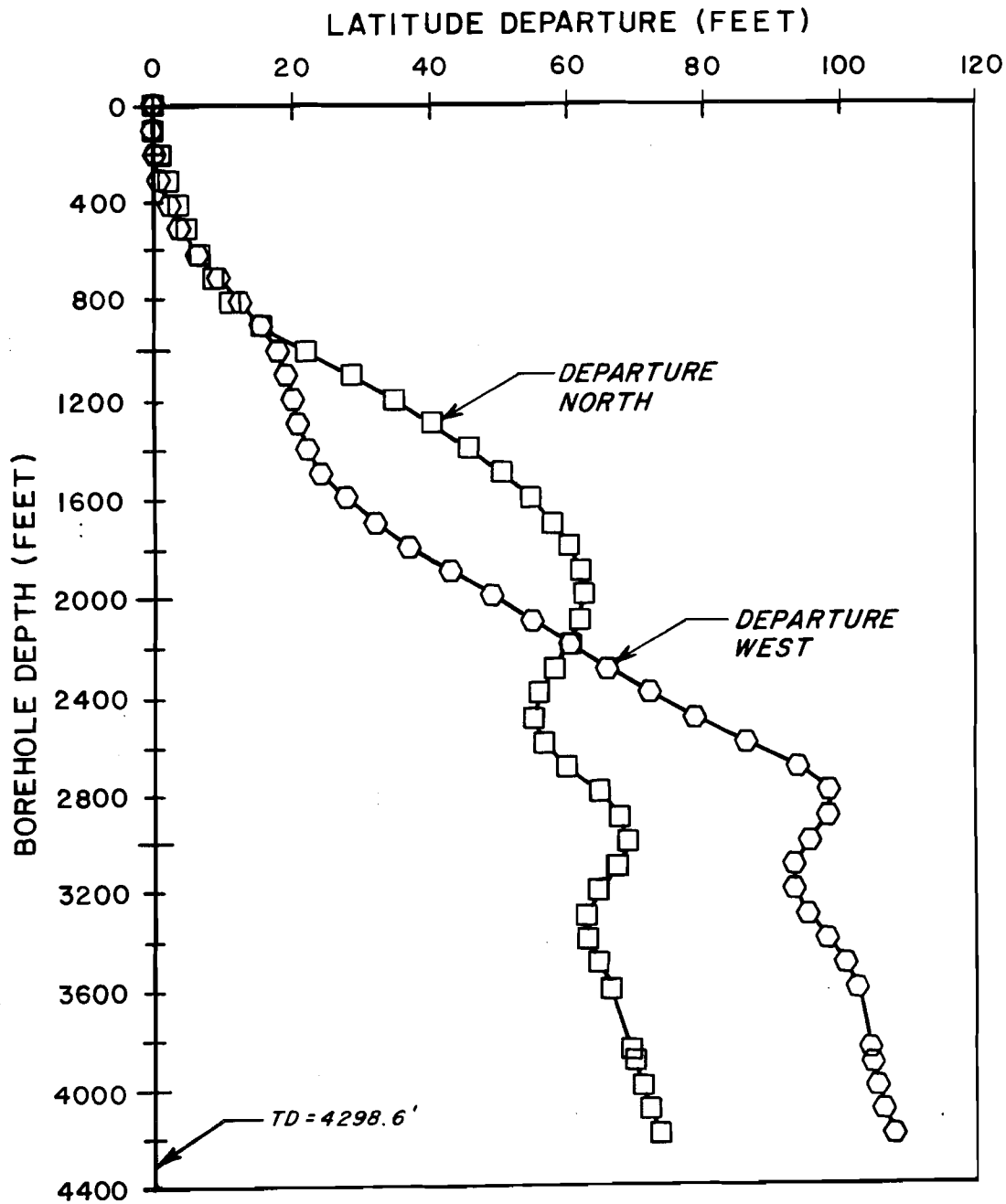

FIGURE 5

CABIN BABY-1
BOREHOLE ORIENTATION
(FROM SPERRY-SUN SURVEY)

PREPARED FOR

WESTINGHOUSE ELECTRIC CORPORATION
ALBUQUERQUE, NEW MEXICO

NOTE:

DEPTHS MEASURED FROM
KELLY BUSHING

D'APPOLONIA

DRAWING NM - 78-648-A161
 NUMBER
 12/20/83
 12/20/83
 L.O.G.
 11-14-83
 CHECKED BY RLB
 APPROVED BY [Signature]
 DRAWN BY

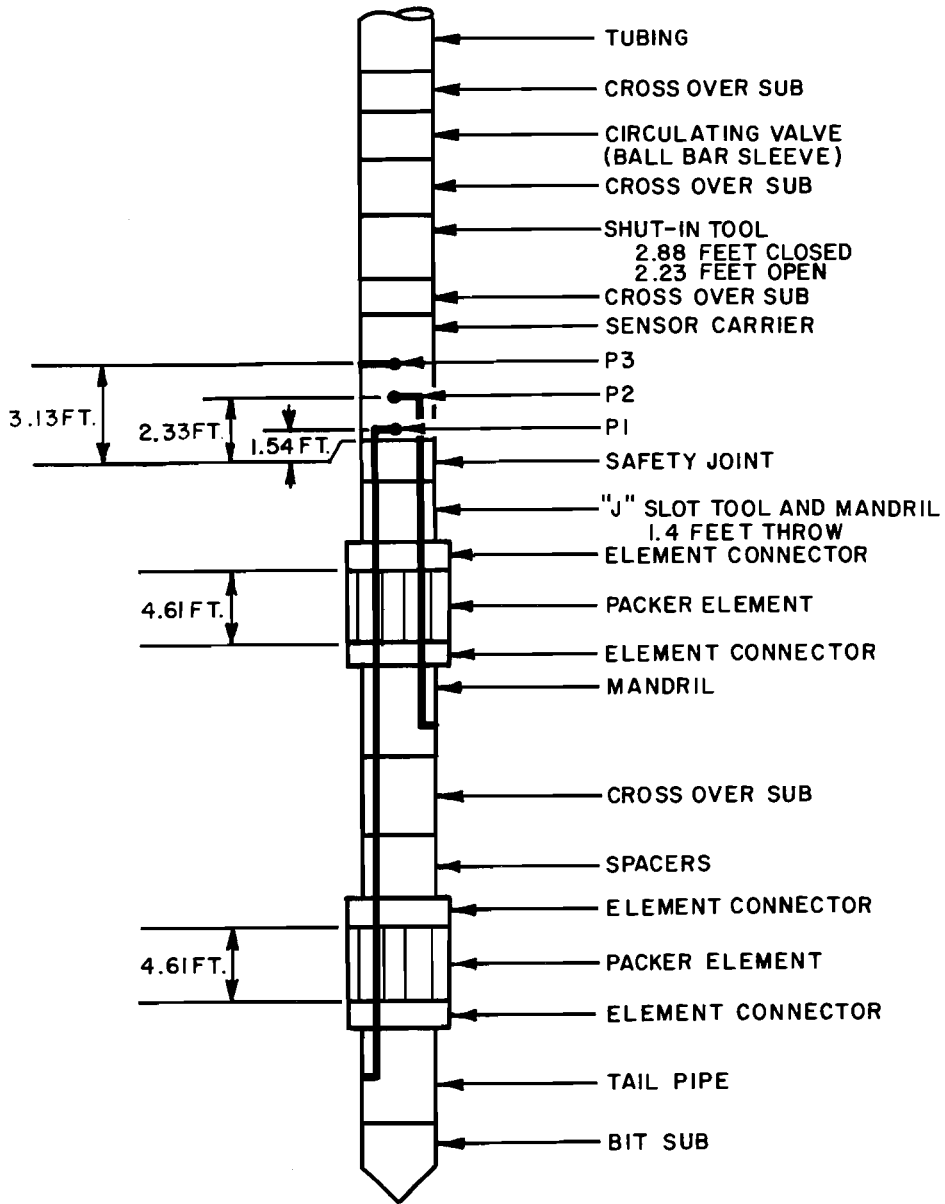

NOTE:

PI IS PRESSURE BELOW THE TESTED INTERVAL;
 P2 IS PRESSURE IN THE TESTED INTERVAL;
 P3 IS PRESSURE IN THE WELL ANNULUS ABOVE THE TESTED INTERVAL.

FIGURE 6

**STRADDLE PACKER
 ASSEMBLY CONFIGURATION**

PREPARED FOR

**WESTINGHOUSE ELECTRIC CORPORATION
 ALBUQUERQUE, NEW MEXICO**

D'APPOLONIA

DRAWING NUMBER NM-78-648-A 159
 DATE 12/20/83
 CHECKED BY RLB
 APPROVED BY [Signature]
 L.O.G. 11/11/83
 DRAWN BY

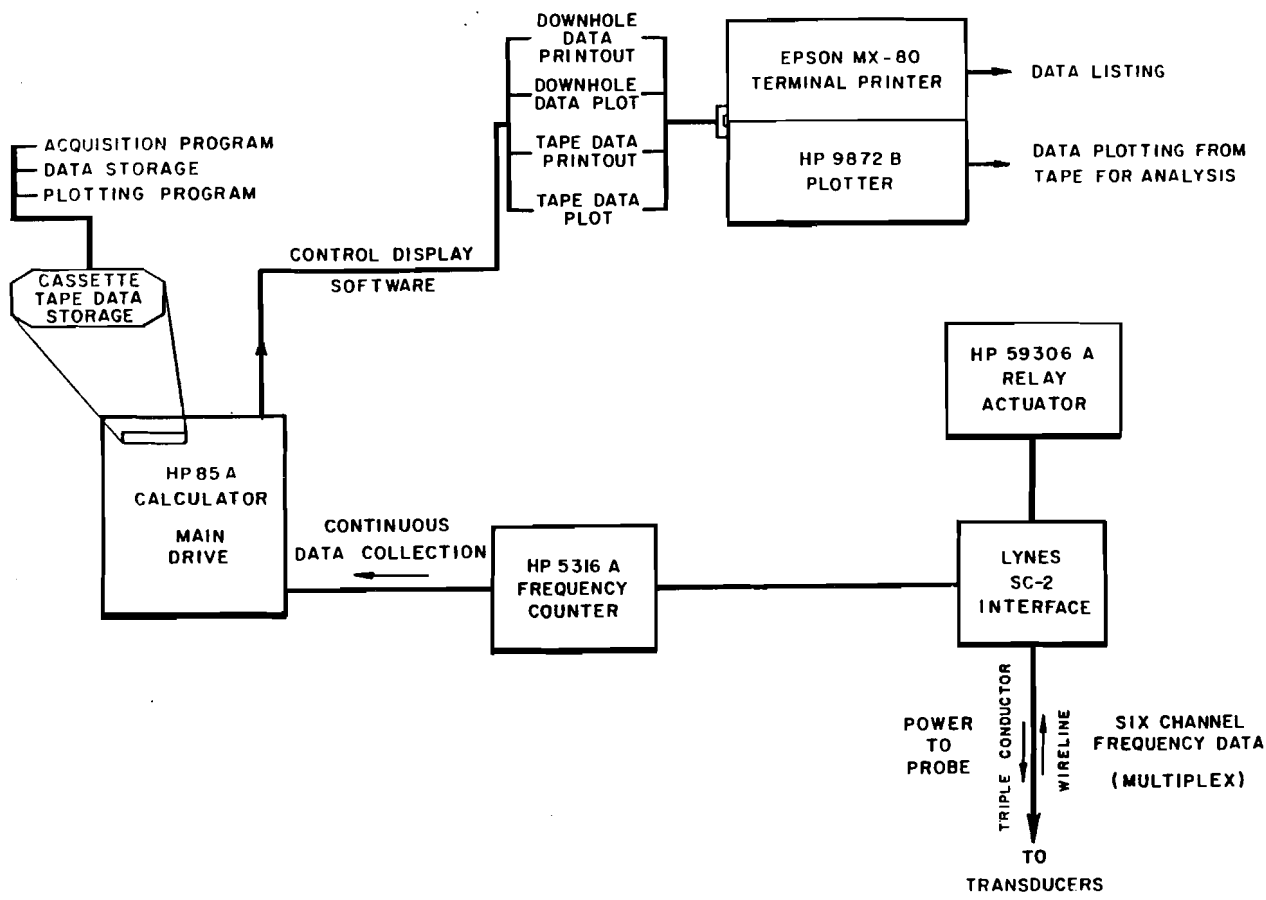
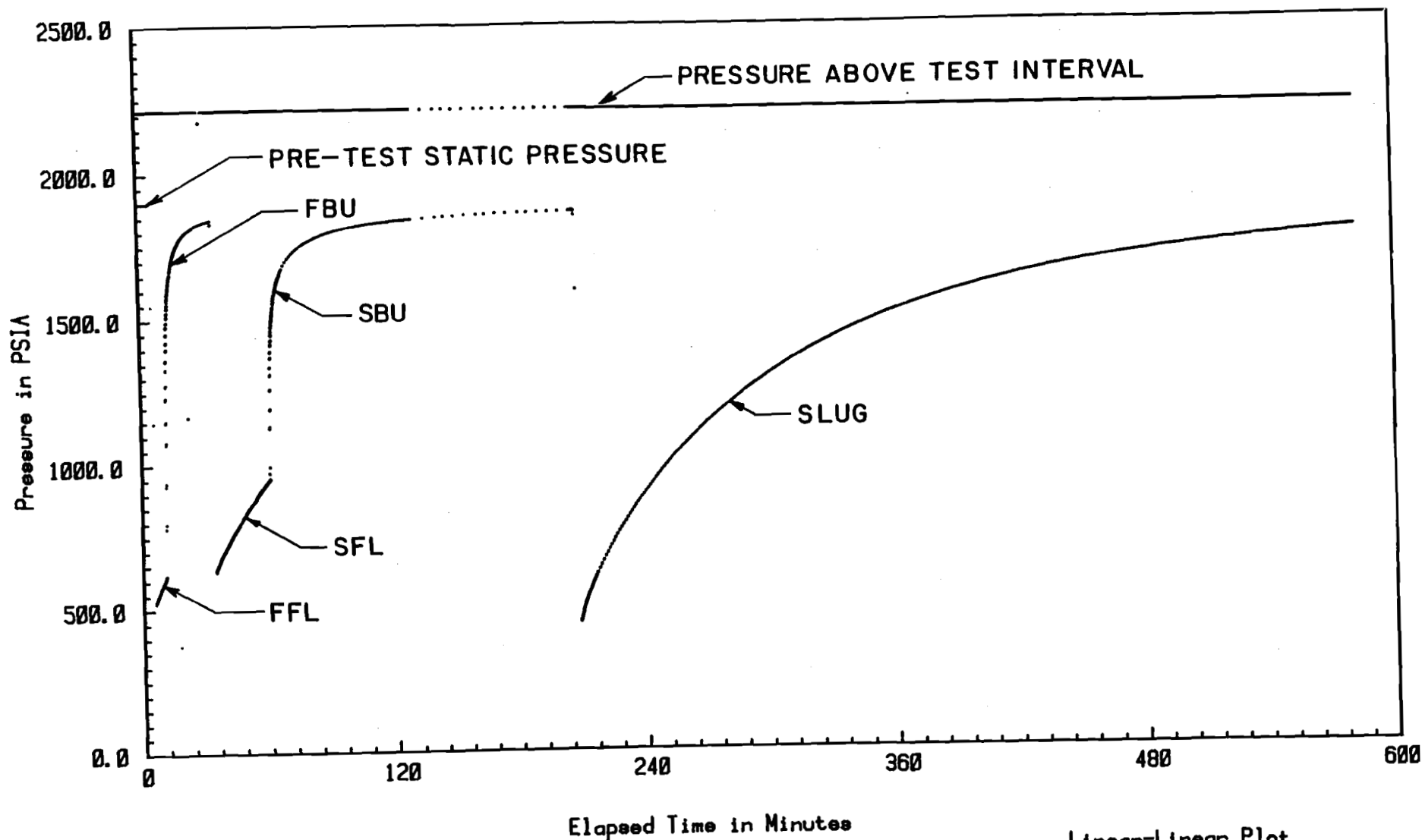

FIGURE 7

SCHMATIC DIAGRAM OF DATA ACQUISITION SYSTEM

PREPARED FOR
 WESTINGHOUSE ELECTRIC CORPORATION
 ALBUQUERQUE, NEW MEXICO

D'APPOLONIA



Start Date: 09/04/1983
 Start Time: 14:34:45

Elapsed Time in Minutes

Linear-Linear Plot
 CB-1.3/DST-4178

FIGURE 8

REAL-TIME PLOT OF DST-4178: HAYS SANDSTONE

WTSD-TME-020

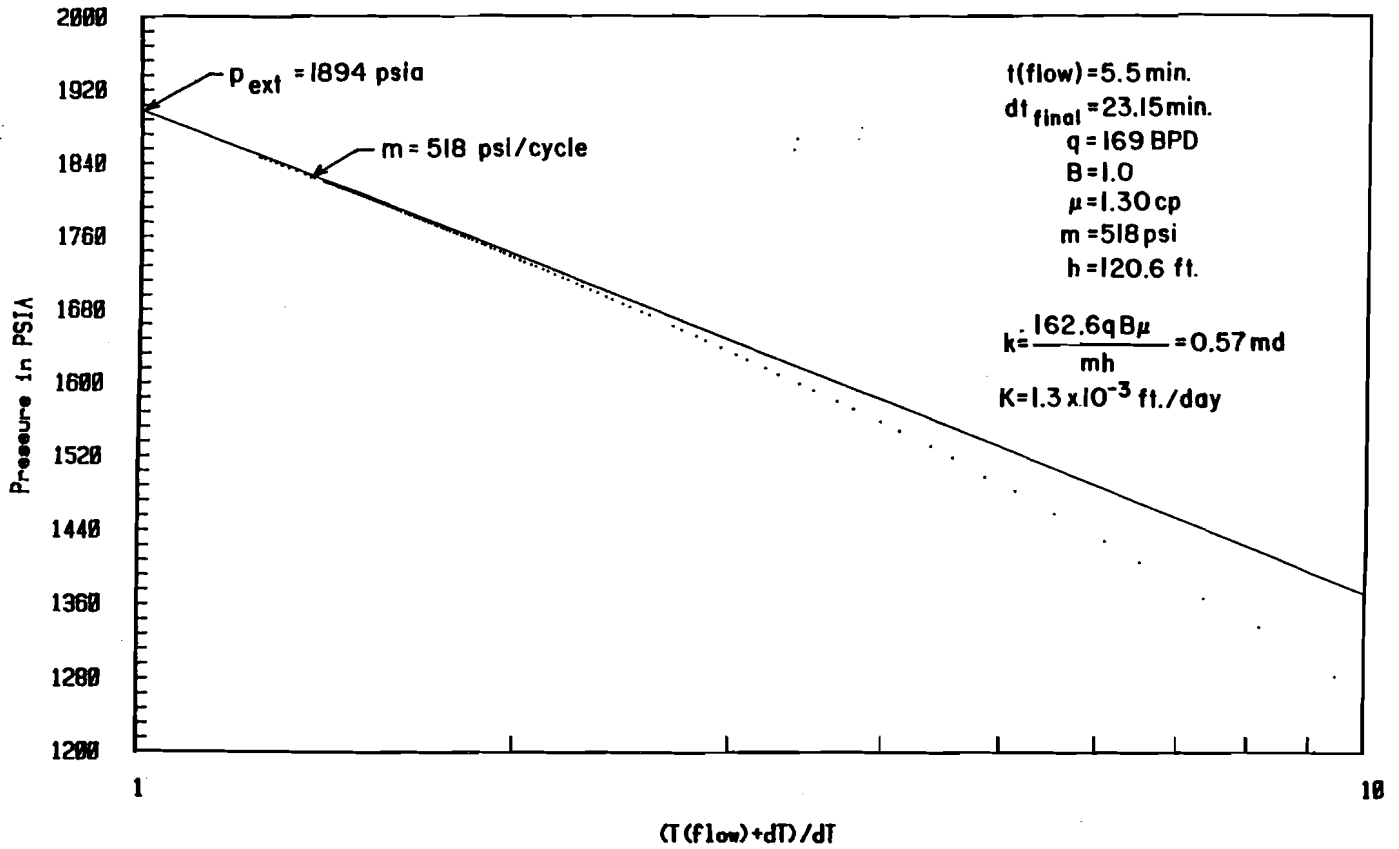

$(T(\text{flow})+dT)/dT$

FIGURE 9

HORNER PLOT OF DST-4178/FBU

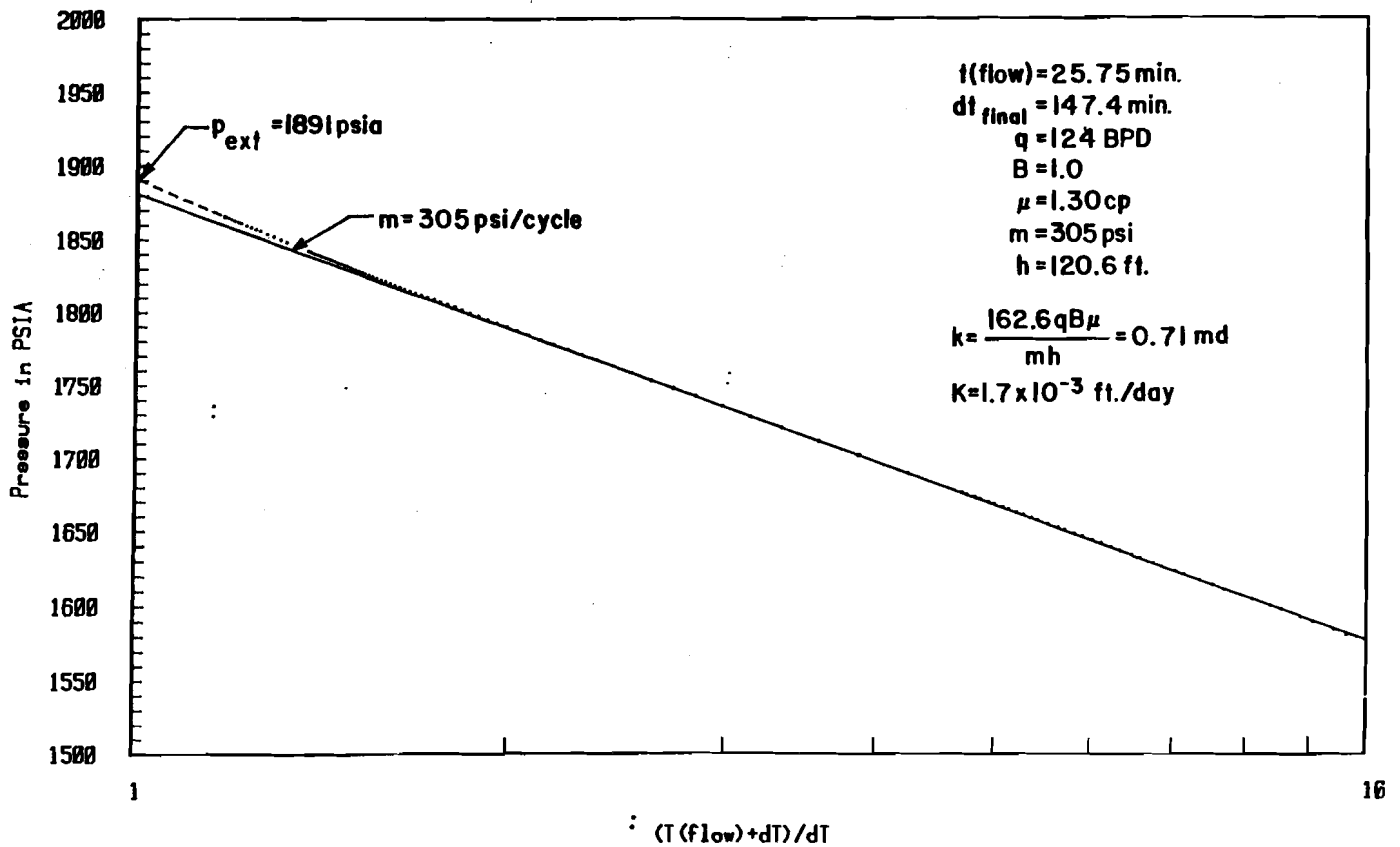

$(T(\text{flow})+dT)/dT$

FIGURE 10

HORNER PLOT OF DST-4178/SBU

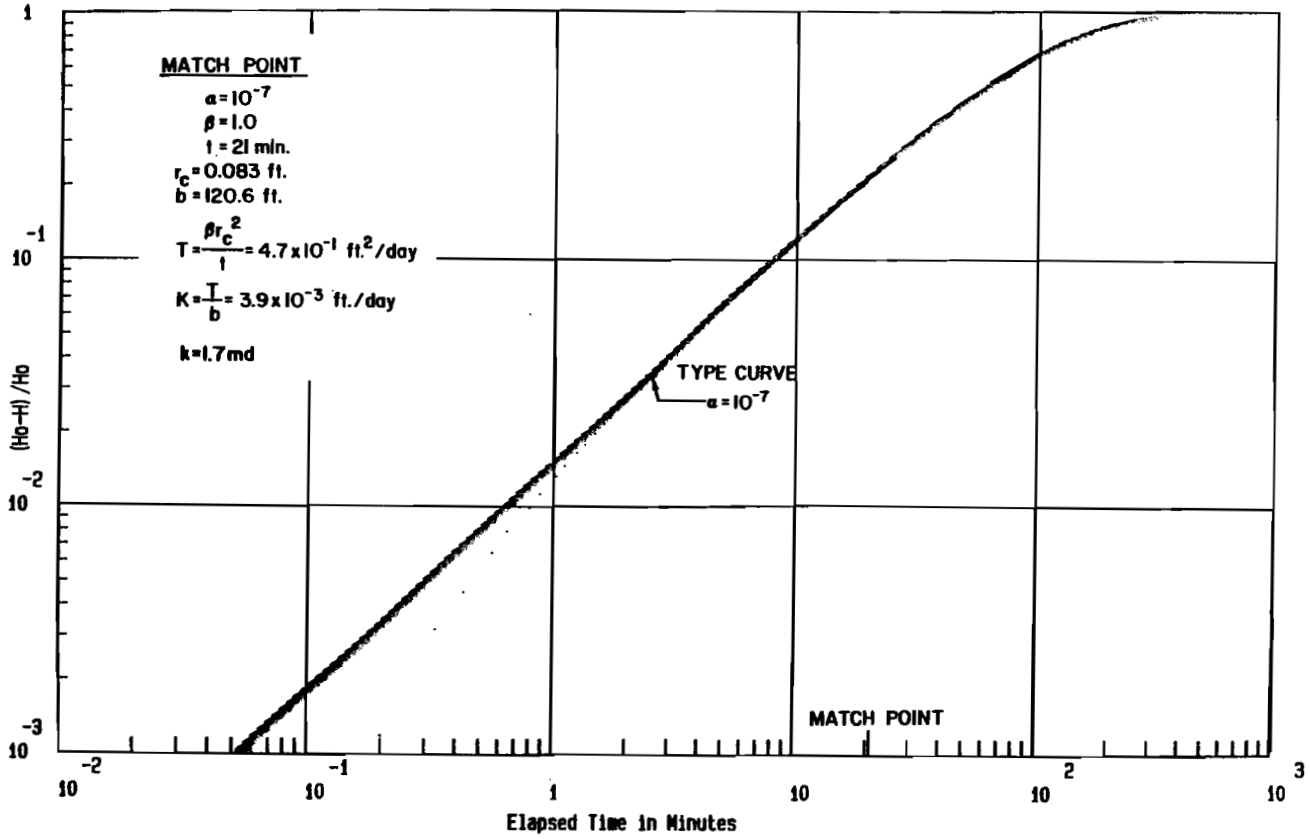

FIGURE 11
 EARLY-TIME SLUG TEST PLOT FOR DST-4178/SFL

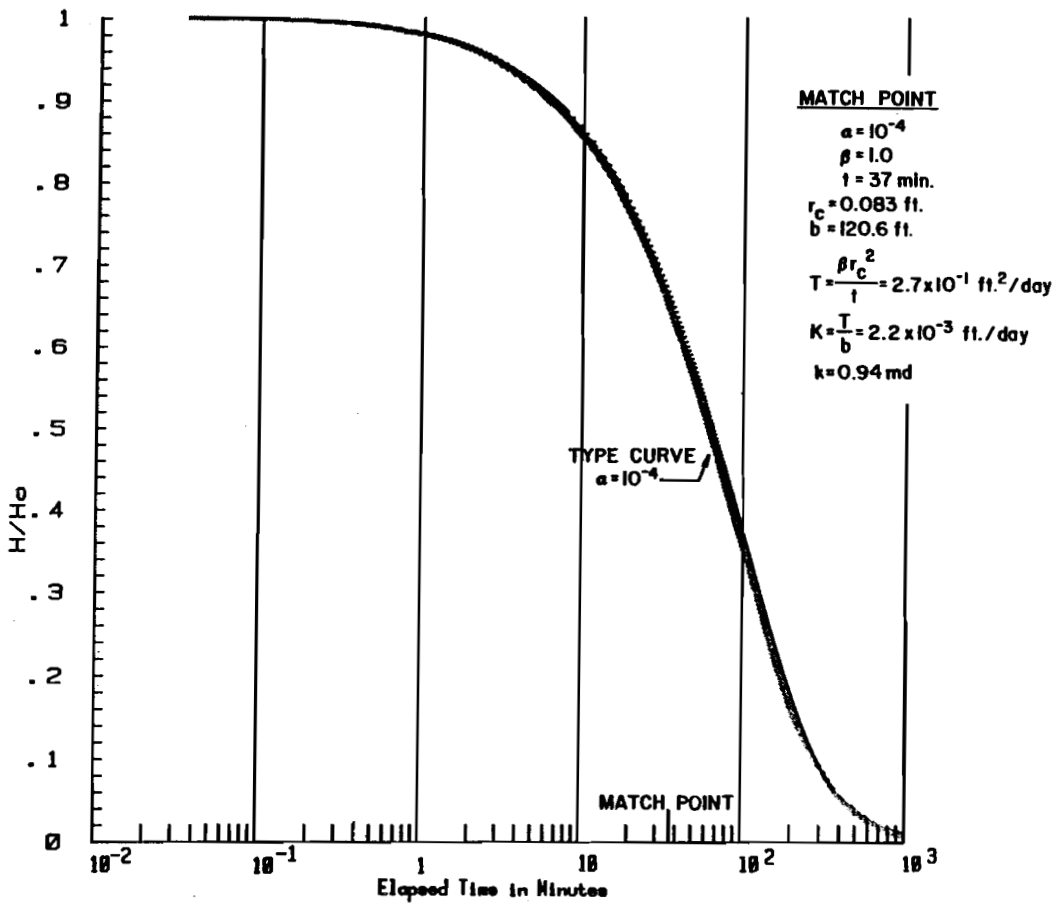
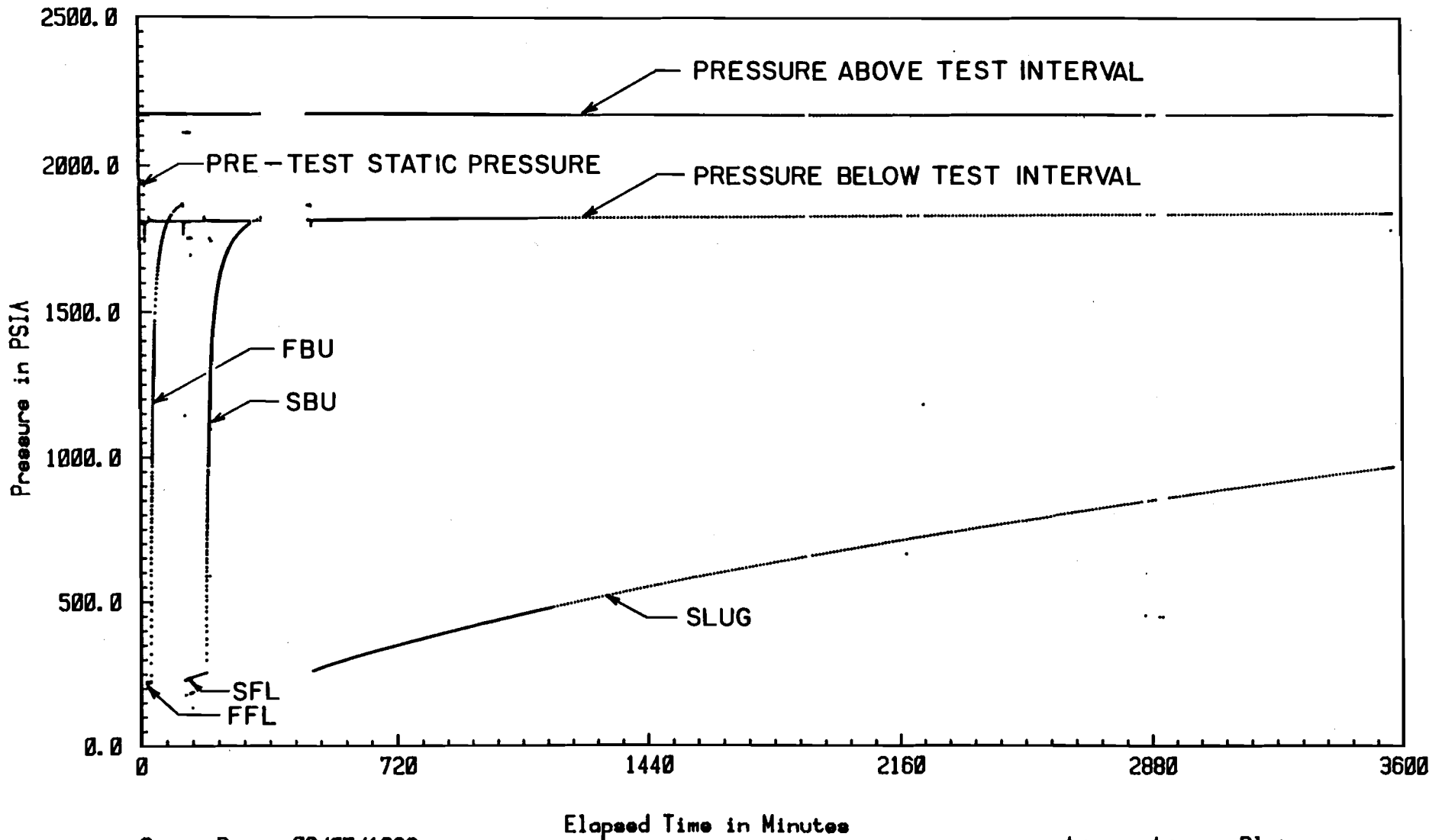

FIGURE 12
 SLUG TEST PLOT FOR DST-4178/SLUG



Start Date: 09/07/1983
 Start Time: 13:42:05

Elapsed Time in Minutes

Linear-Linear Plot
 CB-1.5/DST-4138

FIGURE 13

REAL-TIME PLOT OF DST-4138: OLDS SANDSTONE

WTSD-TME-020

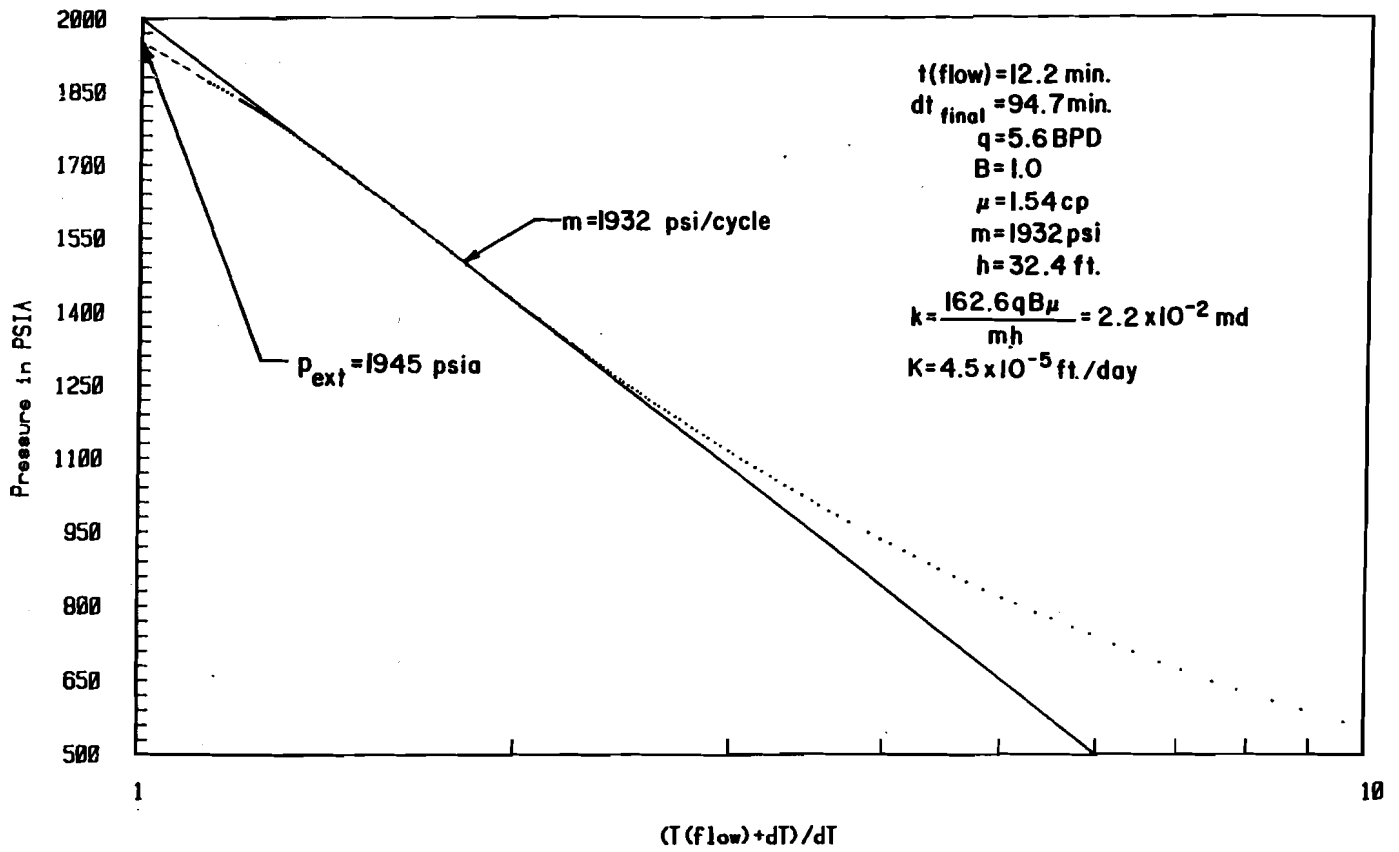

FIGURE 14
HORNER PLOT OF DST-4138/FBU

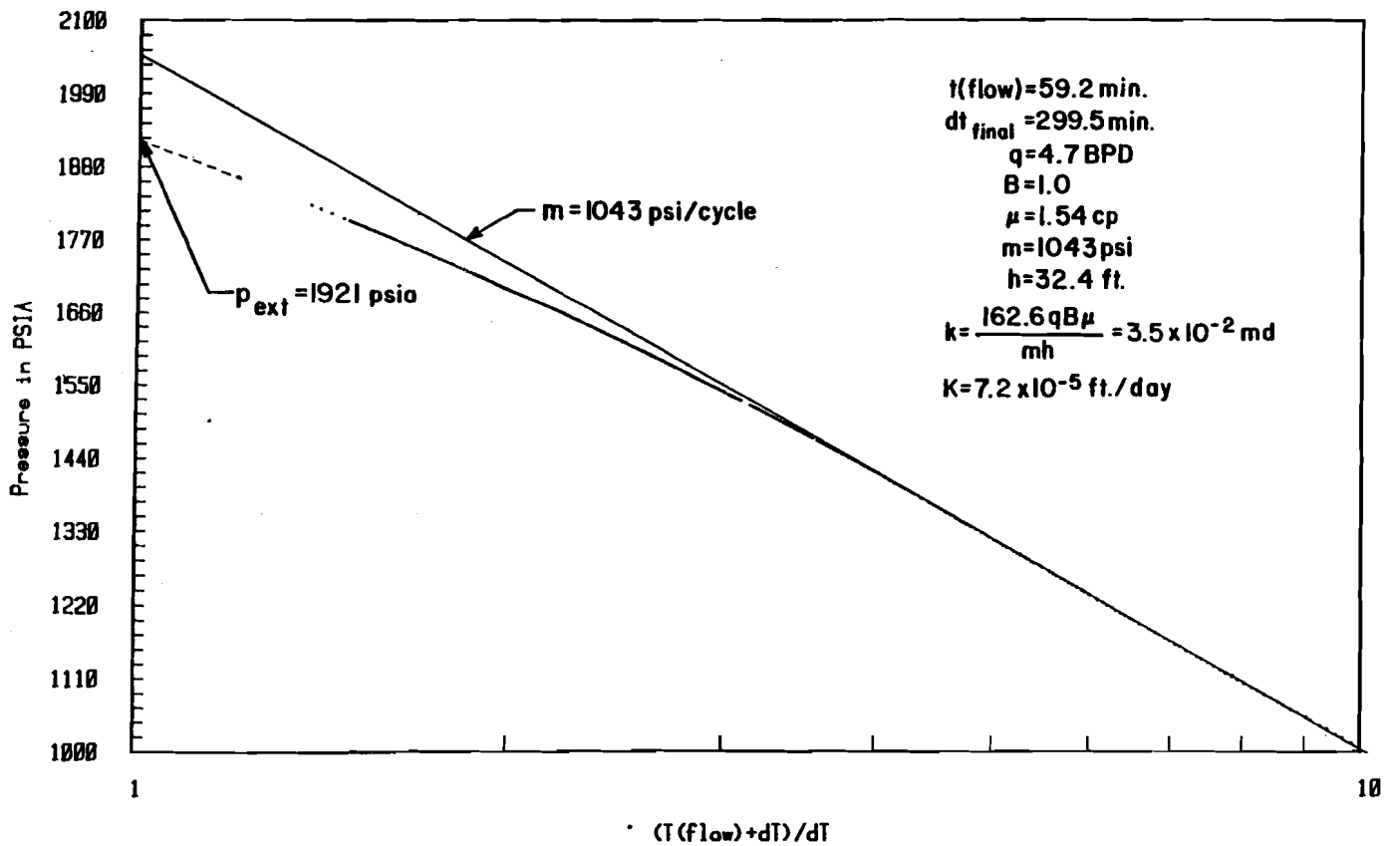

FIGURE 15
HORNER PLOT OF DST-4138/SBU

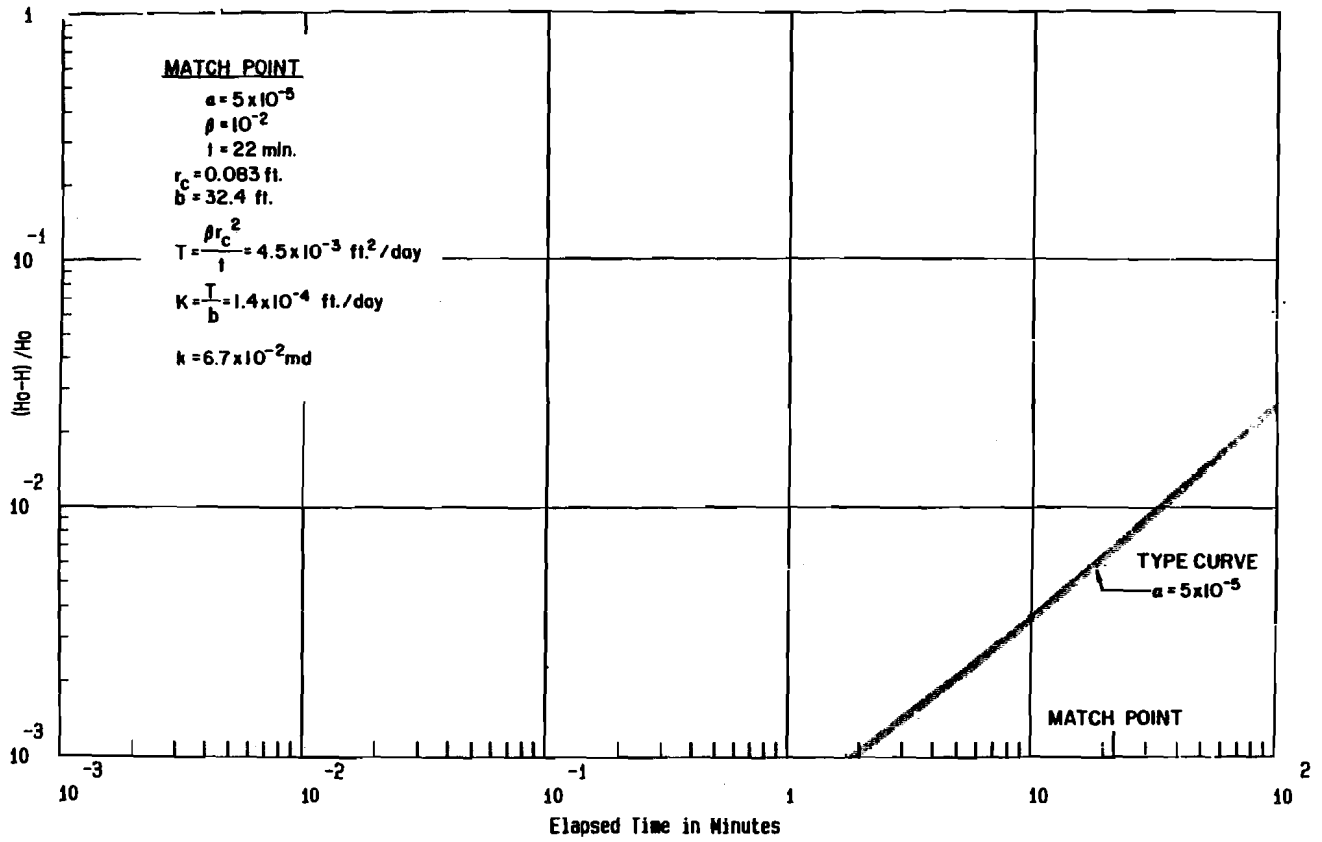

FIGURE 16

EARLY-TIME SLUG TEST PLOT FOR DST-4138/SFL

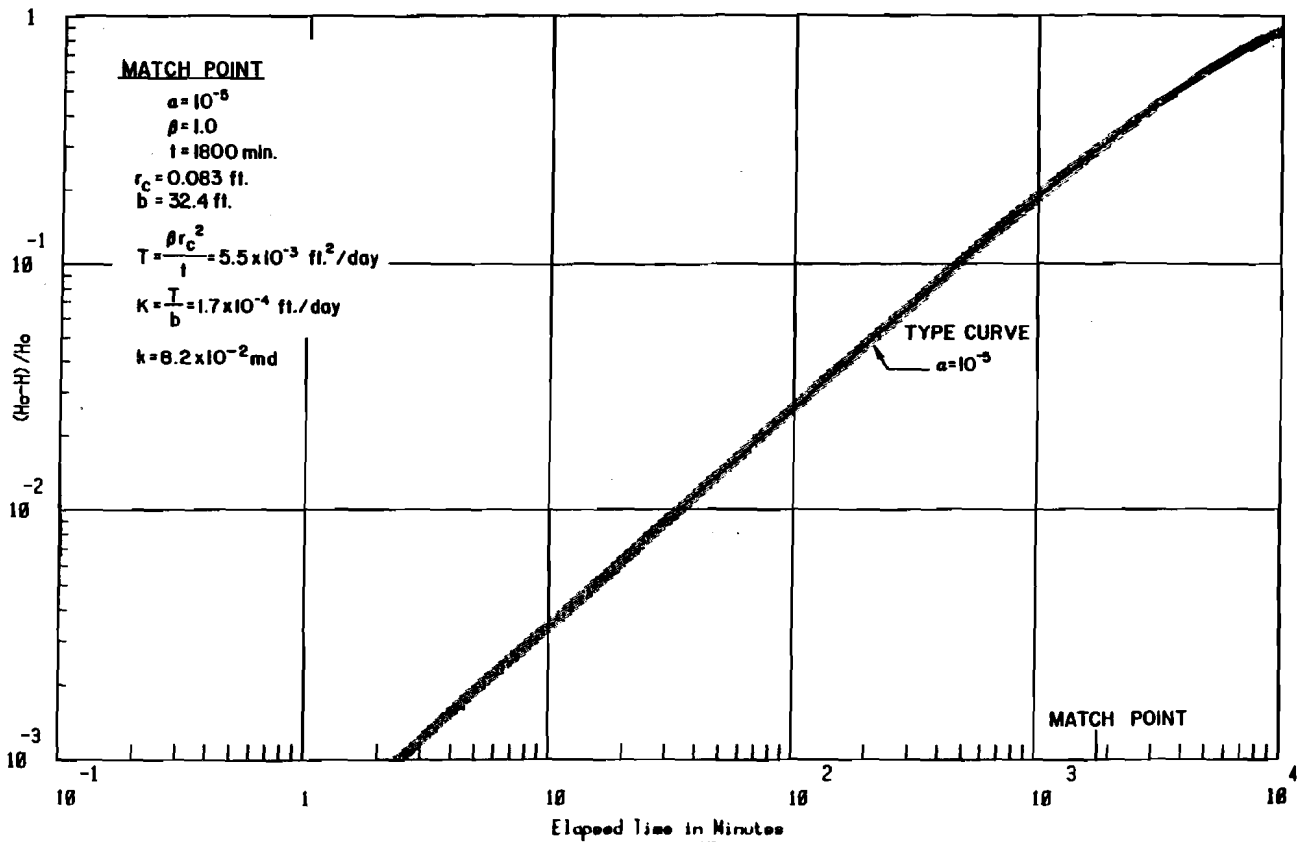
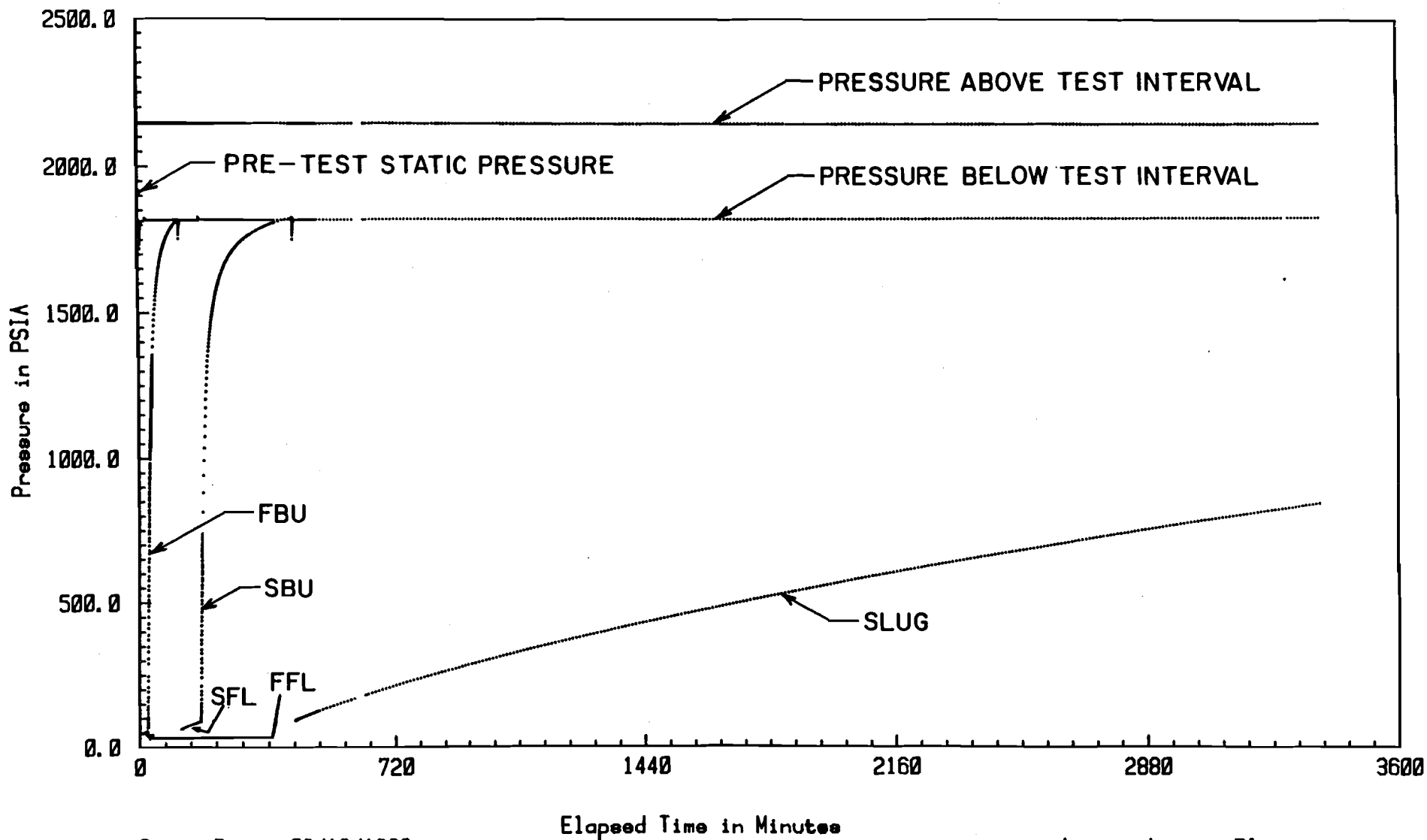

FIGURE 17

EARLY-TIME SLUG TEST PLOT FOR DST-4138/SLUG



Start Date: 09/12/1983
 Start Time: 04:38:16

Elapsed Time in Minutes

Linear-Linear Plot
 CB-1.11/DST-4100

FIGURE 18

REAL-TIME PLOT OF DST-4100: RAMSEY SANDSTONE

WTSD-TME-020

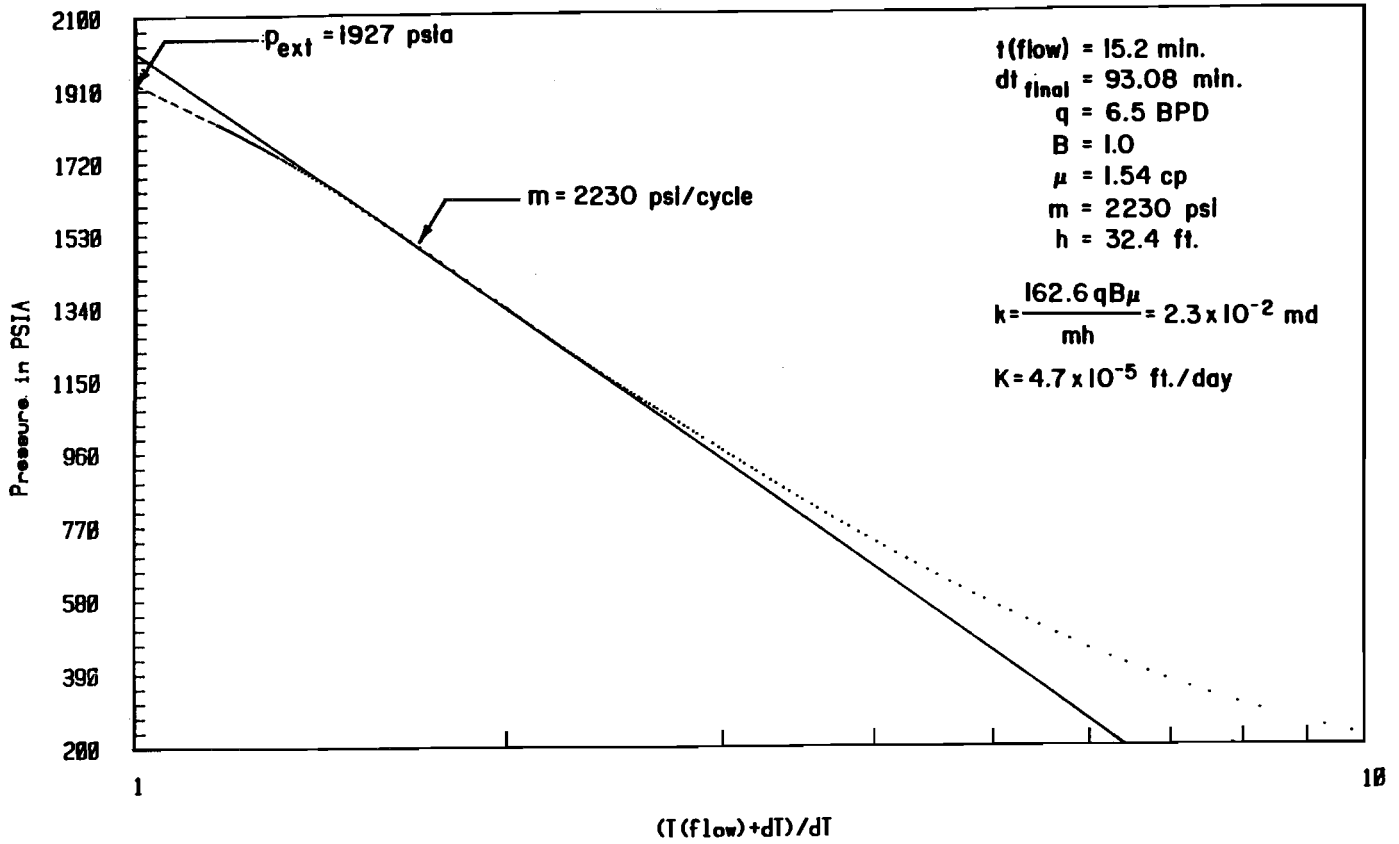

FIGURE 19

HORNER PLOT OF DST-4100/FBU

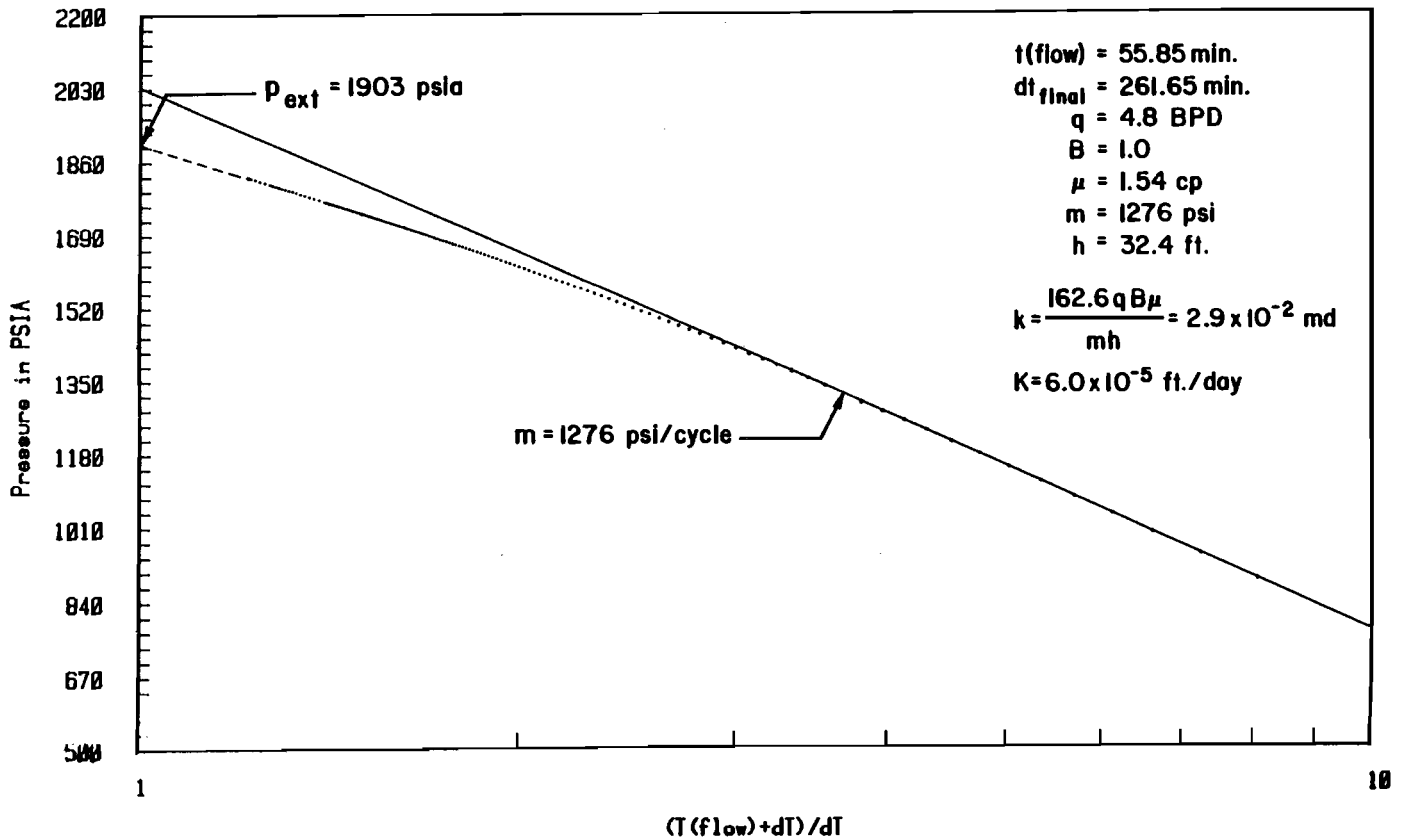

FIGURE 20

HORNER PLOT OF DST-4100/SBU

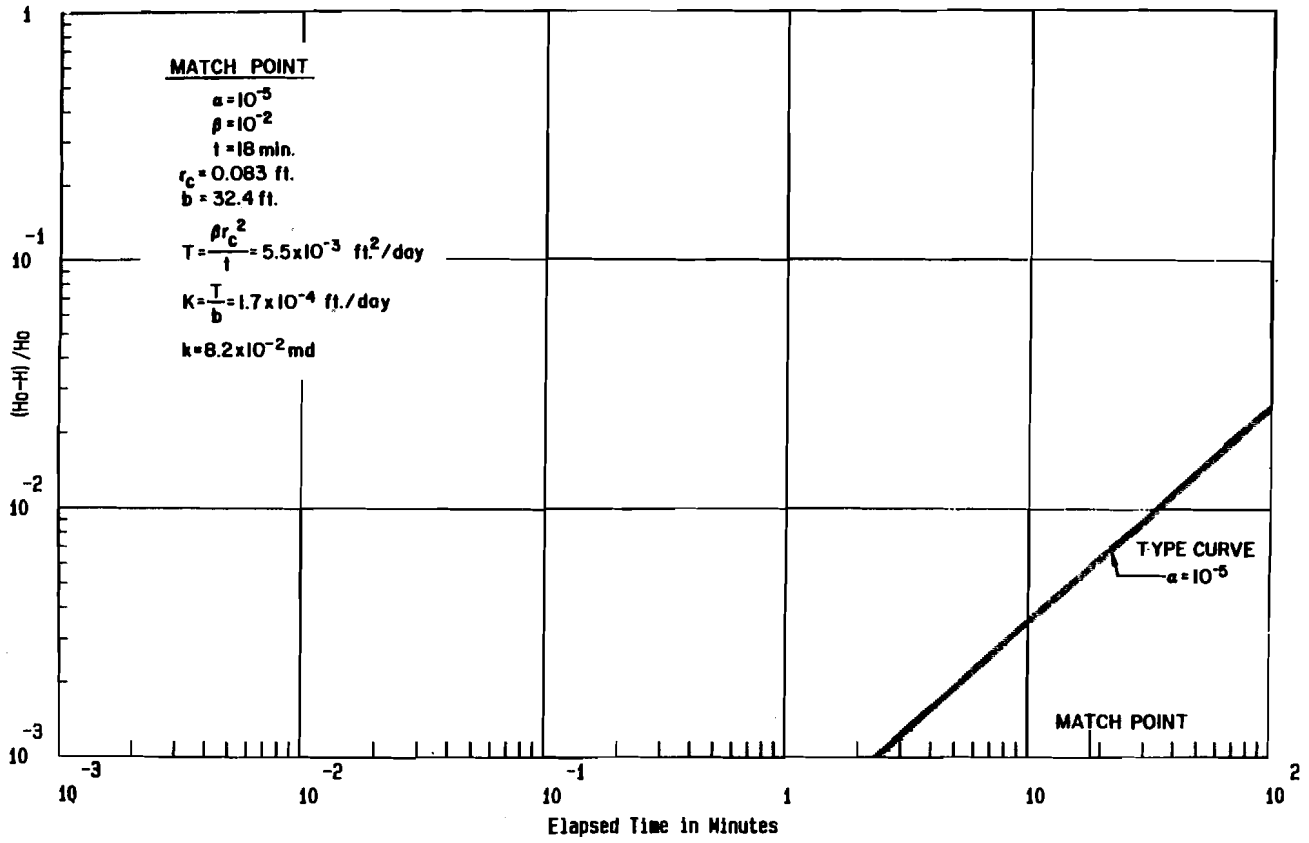

FIGURE 21

EARLY-TIME SLUG TEST PLOT FOR DST-4100/SFL

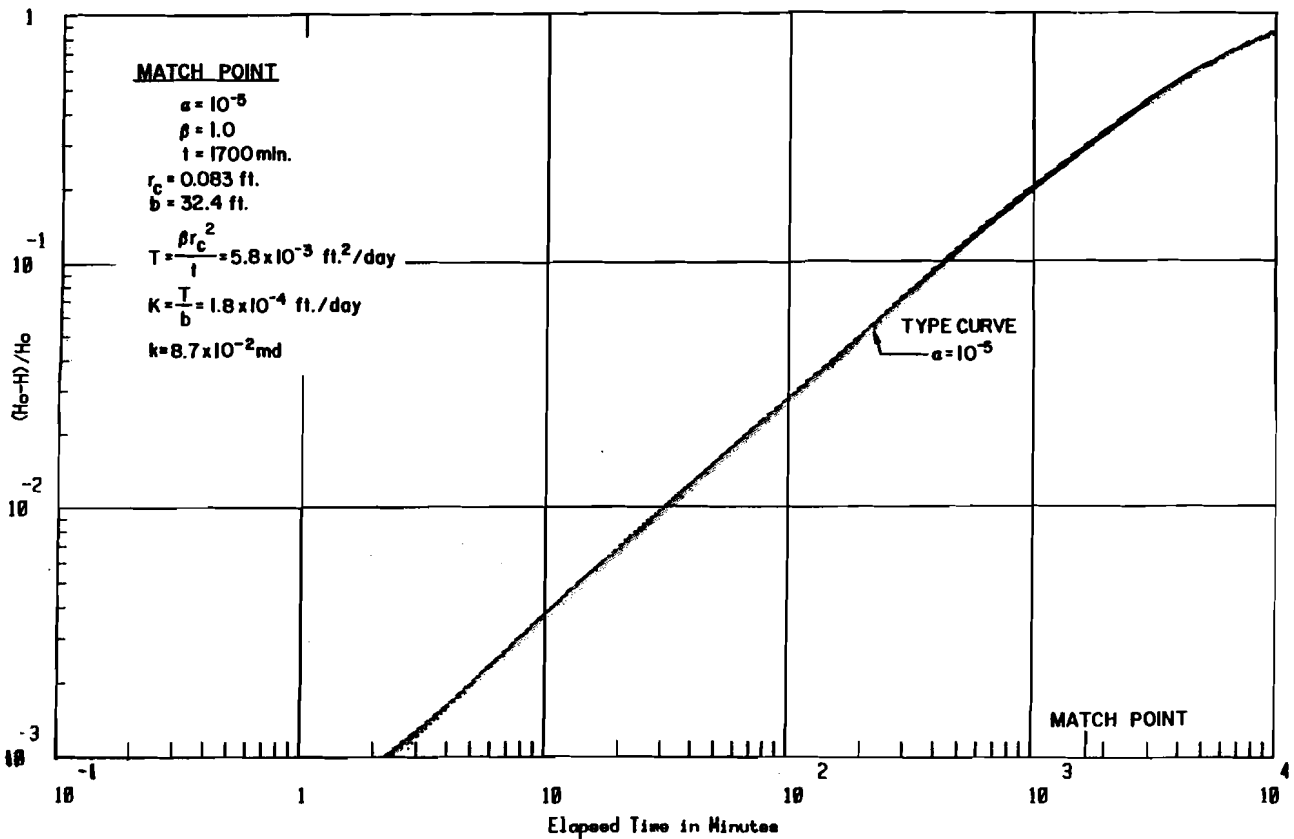
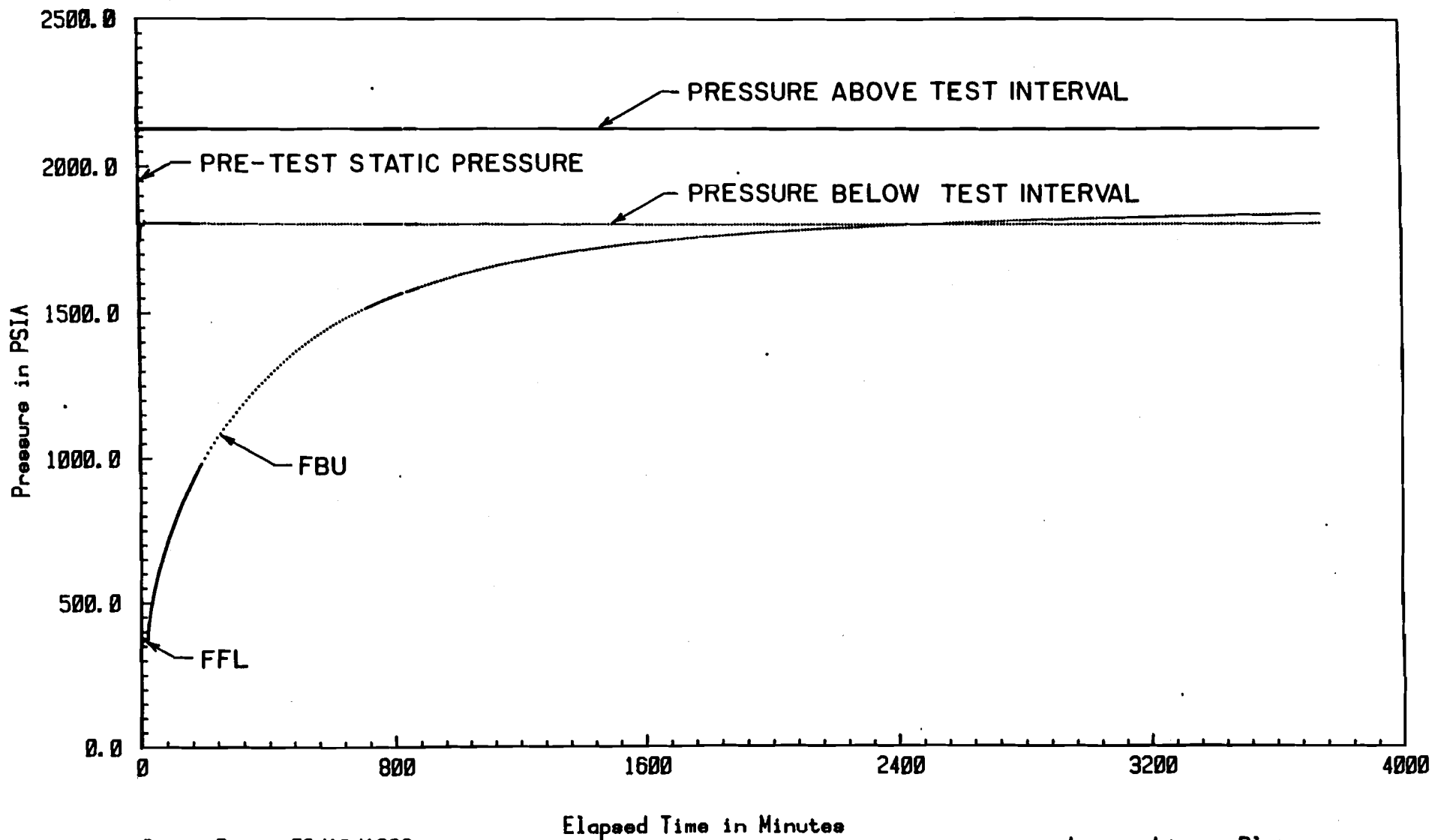

FIGURE 22

EARLY-TIME SLUG TEST PLOT FOR DST-4100/SLUG



Start Date: 09/16/1983

Start Time: 22:49:24

Elapsed Time in Minutes

FIGURE 23

Linear-Linear Plot

CB-1.14/DST-4044

REAL-TIME PLOT OF DST-4044: LAMAR LIMESTONE

WTSD-TME-020

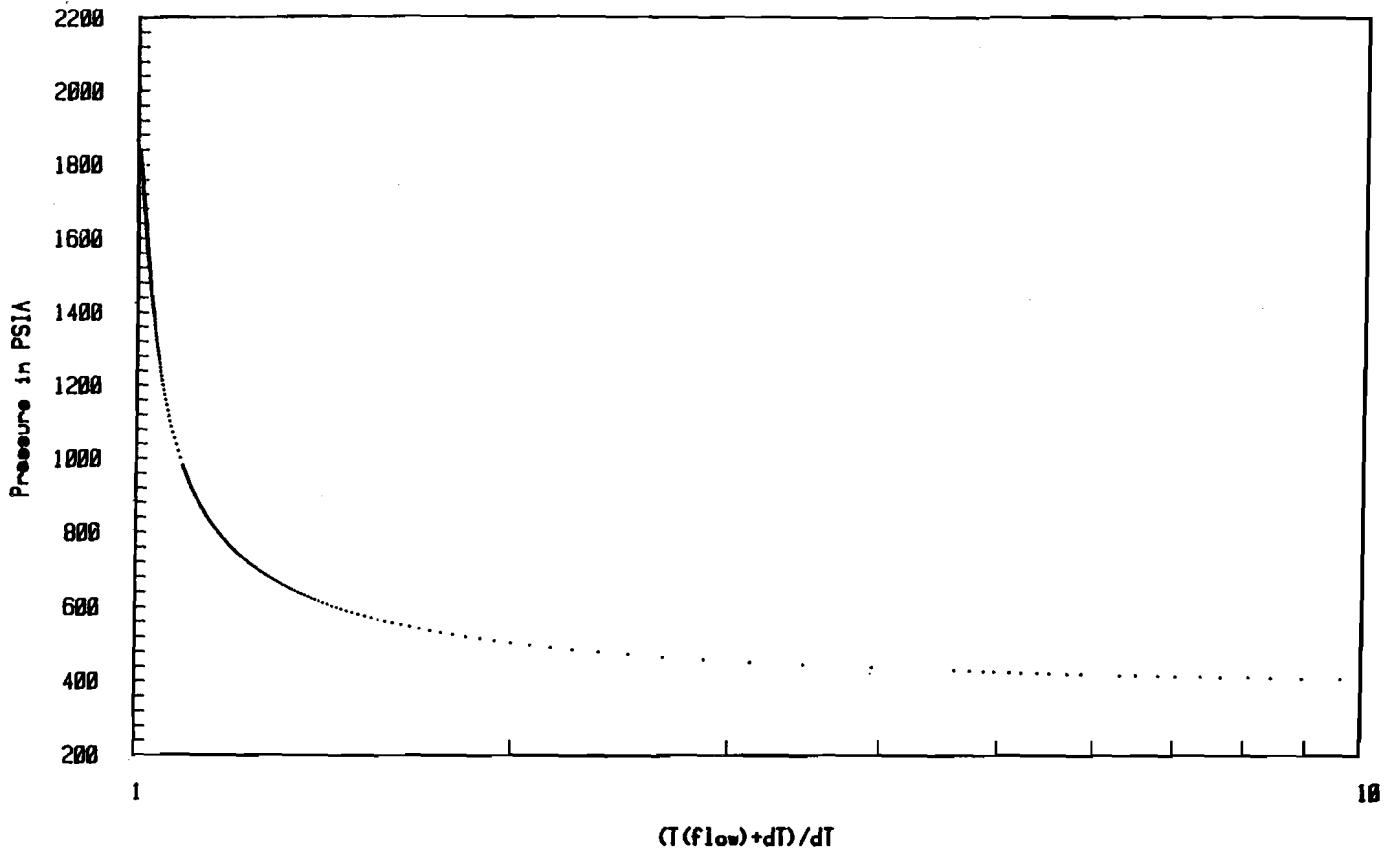

$(T(\text{flow})+dT)/dT$

FIGURE 24

HORNER PLOT OF DST-4044/FBU

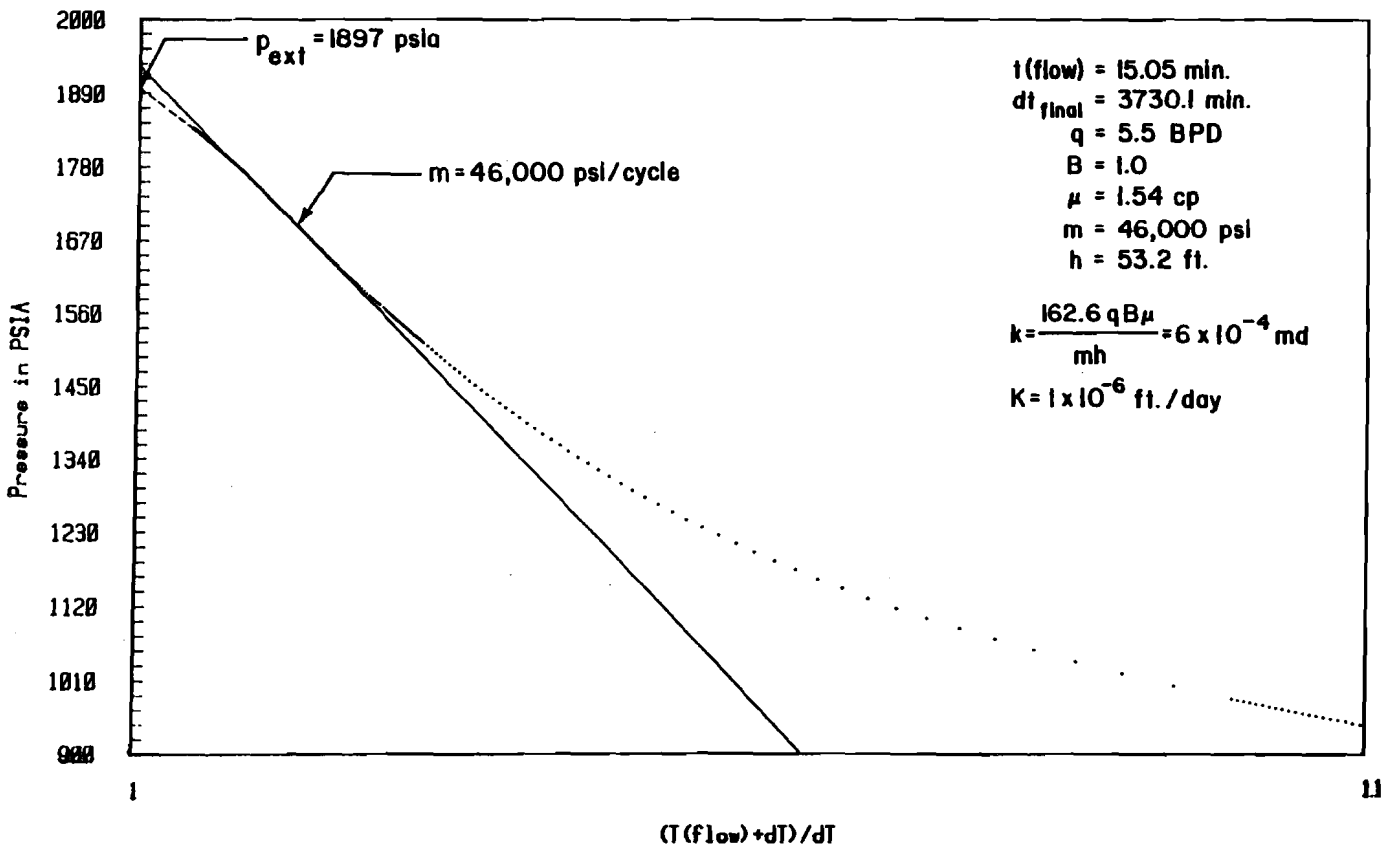

$(T(\text{flow})+dT)/dT$

FIGURE 25

EXPANDED-SCALE HORNER PLOT OF DST-4044/FBU

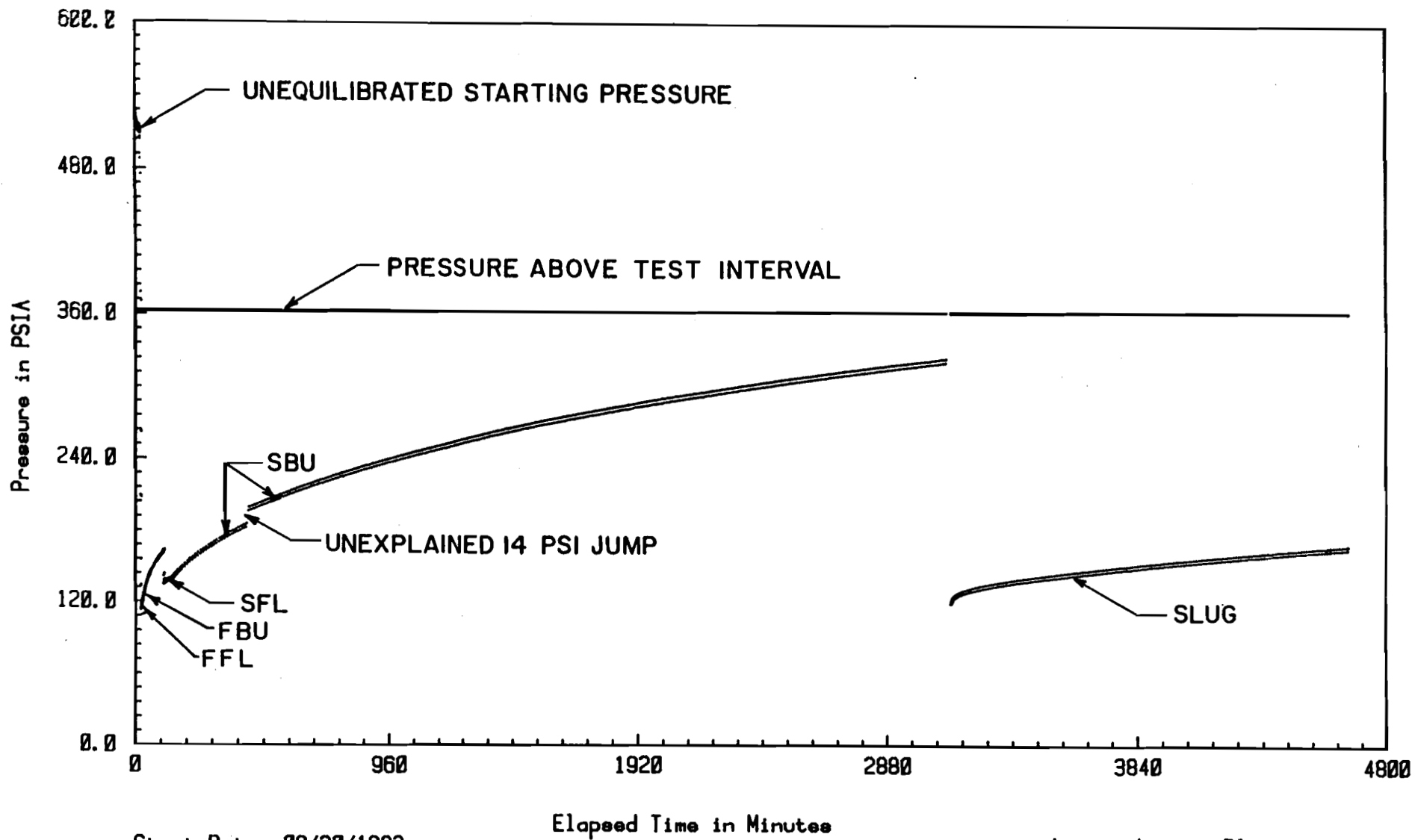

Start Date: 09/20/1983
 Start Time: 10:15:00

Elapsed Time in Minutes

Linear-Linear Plot
 CB-1.16/DST-765

FIGURE 26
 REAL-TIME PLOT OF DST-765: SALADO FORMATION

WTSD-TME-020

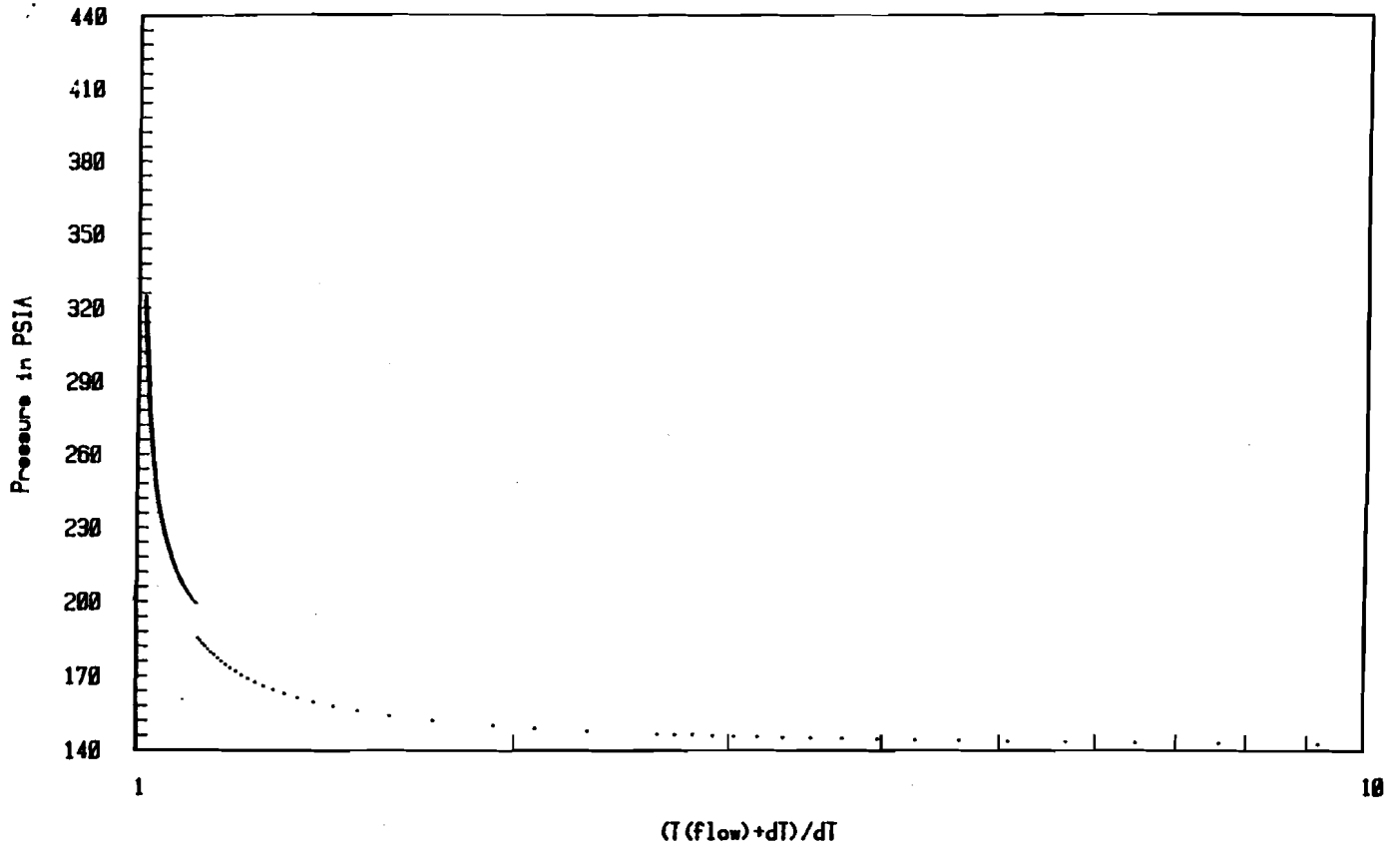

FIGURE 27
HORNER PLOT OF DST-765/SBU

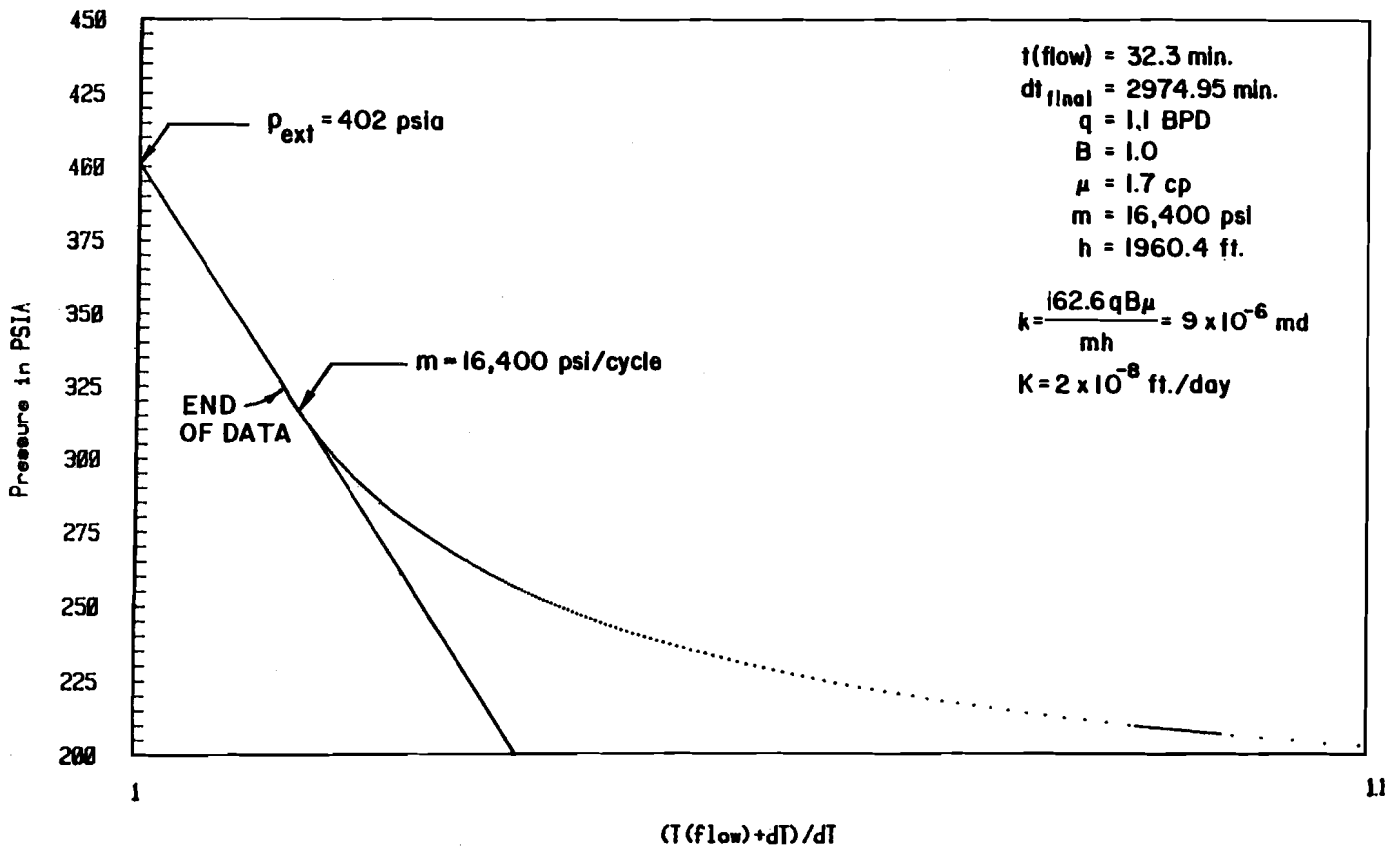

FIGURE 28
EXPANDED-SCALE HORNER PLOT OF DST-765/SBU

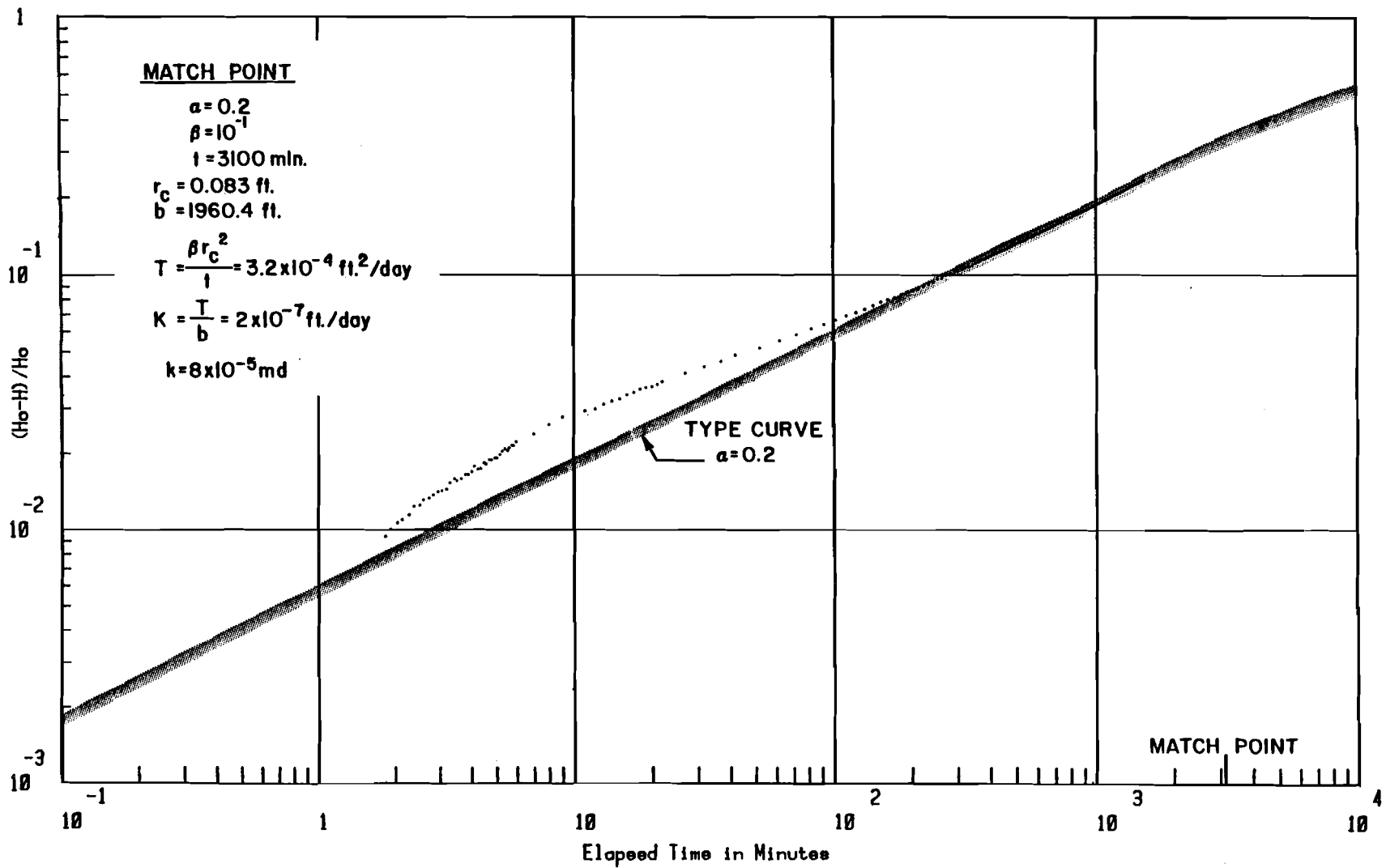
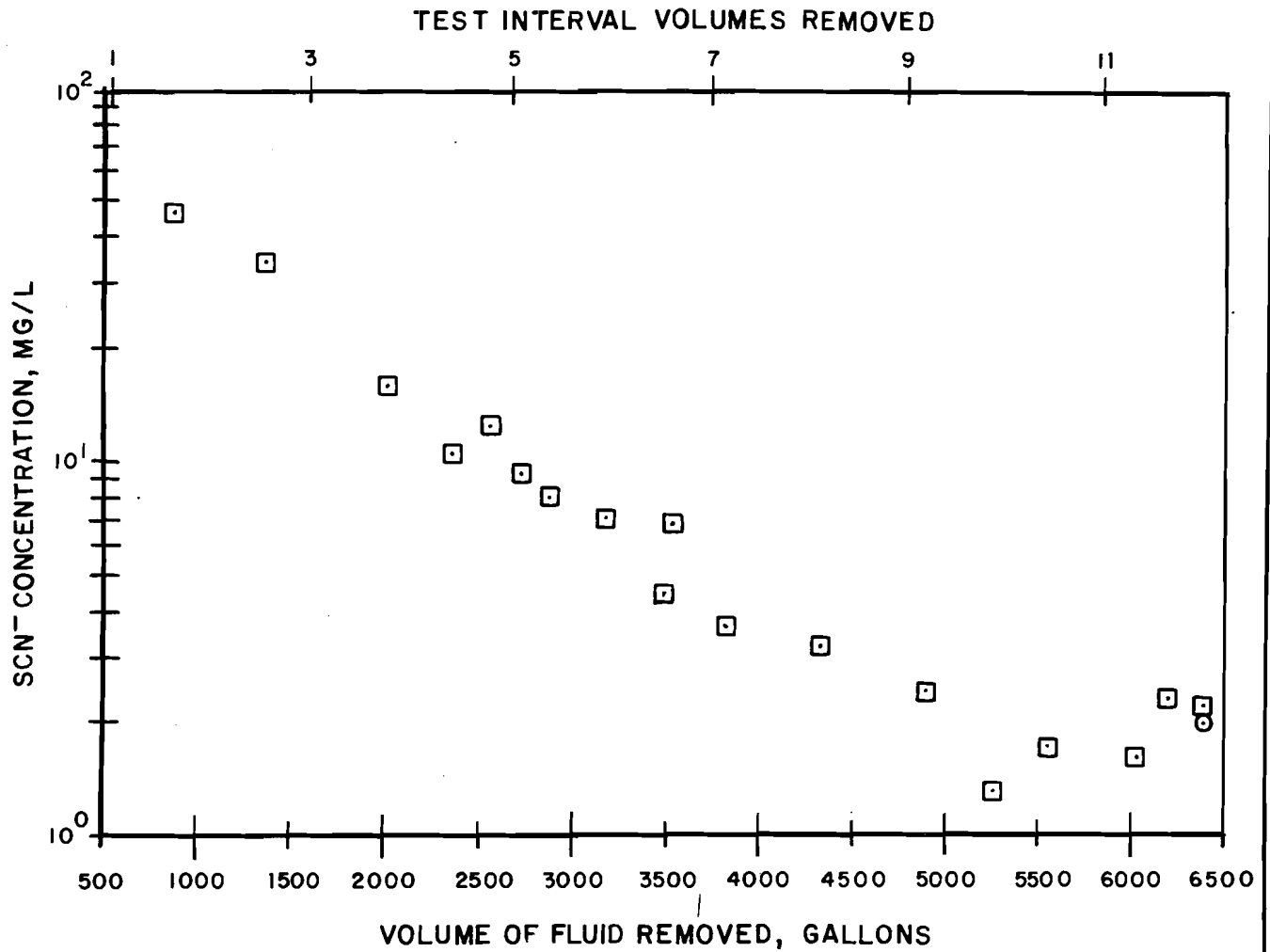

FIGURE 29
EARLY-TIME SLUG TEST PLOT FOR DST-765/SLUG

830

DRAWN BY: L.O.G. 11-11-83
 CHECKED BY: RLB
 APPROVED BY: [Signature]
 DATE: 12/20/83
 DRAWING NUMBER: NM-78-648-A160



- Field analyses
- Laboratory analysis

FIGURE 30
 THIOCYANATE CONCENTRATION
 VS. VOLUME SWABBED
 DST-4178
 CABIN BABY - I
 PREPARED FOR
 WESTINGHOUSE ELECTRIC CORPORATION
 ALBUQUERQUE, NEW MEXICO

D'APPOLONIA

APPENDIX A
JUSTIFICATION

SANDIA NATIONAL LABORATORIES
Albuquerque, New Mexico 87185

July 27, 1983

To: Arlen Hunt - DOE/WPO , Dev Shukla - TSC/D'Appolonia

From: Al Lappin - 6331 *Al Lappin*

Subject - DRAFT SCOPE OF WORK FOR DRILLING AND TESTING OF "CABIN BABY", SEC. 5, T23S, R31E - PHASE I (DMG)

INTRODUCTION

This memo provides a draft scope of work for drilling and hydrologic testing to be carried out at Cabin Baby or, if need be, in a companion hole to be drilled on an extension of the existing Cabin Baby pad; this possible new hole is here termed "Cabin Baby-2". It is intended that the bulk of the work described here be fielded by D'Appolonia/TSC, under the technical supervision of Sandia National Laboratories.

Obviously, some of the specifications given here may be either in error or incomplete; if so feel free to contact either me or Don Gonzalez.

OBJECTIVES

The overall effort planned for the Cabin Baby pad has three main objectives:

1. Determination of the head potentials, in situ hydrologic properties, fluid compositions, and brine densities within the Rustler Formation.
2. Determination of the head potentials, in situ hydrologic properties, fluid compositions, and fluid densities within permeable zones in the Ramsey Member of the Bell Canyon Formation.

Accomplishment of objectives 1 and 2 will allow reliable a priori calculation of directions of fluid movement to be expected at Cabin Baby in the event of interconnection of the Bell Canyon and Rustler aquifers.

3. Intentional interconnection of the Rustler and Bell Canyon "aquifers", followed by monitoring of the actual direction(s) of resultant fluid movement.

The work described here, part of the overall effort to be carried out the Cabin Baby pad, has one major objective:

1. Collection of the data required for the best possible estimation of both "fresh-water" and "brine" heads within selected "permeable" sands contained in the Ramsey Member of the Bell Canyon Formation. This objective, in turn, requires:

- A. Determination of RELIABLE down-hole fluid pressures. Reporting of these pressures, which will be based on conventional and/or modified drill-stem testing, must include estimation of the uncertainty of reported values.
- B. Collection of the best reasonable brine samples from each of the permeable zones selected: these samples are required for both chemical analysis and measurement of bulk fluid density. The uses to which these data will be put require that on-site analyses be made to distinguish between "tracer-tagged" drilling fluid and formation brines, and to determine whether or not additional sampling is required across a given interval.
- C. Determination that all of the Ramsey Member and underlying Ford Shale Member have been penetrated by the existing or newly drilled hole.
- D. Coordinated selection of the Ramsey intervals to be tested. This selection will be made cooperatively by USGS/SNL/TSC, and involve invited participation by the NM/EEG.

Testing of the Rustler Formation and monitoring of fluid movements resulting from intentional interconnection of the Rustler and Bell Canyon will be carried out by Sandia after completion of testing in the DMG.

1. PRESENT STATUS OF HOLE, RECENT HISTORY, WORK TO BE COMPLETED BEFORE TSC RIG IS ON-SITE

The Cabin Baby hole was originally drilled in 1973, after which it was apparently loaded with brine to the top of casing, and a steel cap welded in place over the top of the hole. The hole is cased to a depth of approximately 560 feet (just below the Rustler-Salado contact) with 13 1/4" I.D. casing, and is open (12 1/4" Diam.) to at least 3400 feet. The hole was reentered by Sandia on or about 7/11/83, the intent being to clean out/condition the hole for hydrologic testing. This operation proceeded smoothly with a Failing 2000 rig (using an 8 1/2" bit on the end of 2 3/8" tubing), to a depth of approximately 3400 feet, where a "blockage" was encountered. Approximately 6 hours were then spent trying to determine the nature of this blockage. The "springy" nature of the obstruction is presently taken to indicate that the most likely material encountered was wire-line or cable. Some difficulty was encountered in extricating the drill bit and tubing from the top of the blockage. After exiting the hole, it was again filled with brine/mud to the top of casing. The fluid level has since been relatively stable, dropping only about two feet below the top of casing in approximately one week.

The reported T.D. of Cabin Baby is 4150 feet, which means that the condition of approximately 750 feet of hole remains-unknown. The stability and height of the fluid column presently supported in the hole is taken to indicate the probability of a bridge plug or grout plug having been emplaced above the Bell Canyon. Options discussed in the scope of work outlined below are based on this assumption.

The USGS will run standard geophysical logs in Cabin Baby to a depth of approximately 3400 feet, probably during the week of 7/25.

SCOPE OF WORK

A. HOLE COMPLETION

This section describes options likely to be encountered during attempts to complete Cabin Baby (or Cabin Baby-2) to adequate depth for testing. Steps are described, as much as possible, in sequence.

I. Initial hole reentry. We request that Cabin Baby initially be reentered with a slim tool/spear, the intent being to penetrate through the blockage at 3400 feet and to tag either T.D. or the top of any plug that may be present below 3400 feet. If successful, this operation will greatly decrease remaining uncertainties concerning hole completion. If unsuccessful, the contractor should proceed to step II. It is intended that no more than 2 days be spent in attempting to penetrate the blockage; however, the option must be retained to extend this time period.

II. Fishing. After the attempt to penetrate the 3400-foot blockage with a slim tool/spear, a period of no more than two days should be expended in attempting to fish the hole to T.D. or the first plug below 3400 feet. However, the option must be retained so that, if sufficient progress is being made, this time span can be increased; in addition, if a plug is encountered, a second fishing operation may be needed.

III. Drilling.

A. If the fishing operation is successful in opening the hole to T.D., the hole may then need to be logged, in order to determine whether or not the base of the Ramsey has been reached. The attempt is presently being made to obtain "existing" geophysical logs for Cabin Baby. If existing logs prove to be adequate, and indicate both that the Ramsey is completely penetrated and the Ford Shale at least entered, and that the hole T.D. recorded after fishing shows that the entire Ramsey is accessible for testing, no drilling will be necessary as part of this contract. If existing logs are inadequate, the hole will need to be logged before proceeding further.

If either existing or newly run logs indicate that the Ramsey has not been completely penetrated in the existing Cabin Baby, the hole will need to be drilled through the bottom of the Ramsey and at least into the Ford Shale. During this drilling, 100% core should be taken. This core should be a minimum of 2" in diameter, resulting in a minimum hole diameter of 5". Maximum hole diameter should be 12 1/4".

B. If the fishing operation is successful, but only opens the hole to a plug above T.D., this plug should be drilled out. A second fishing operation may then be needed to reach T.D.; once T.D. is reached, the drilling and logging options remain as in IIIA above. If a plug is encountered, a blow-out preventer should be used during drilling to T.D., because of the slight possibility of encountering pressurized brine.

C. If either the initial or a subsequent fishing operation is unsuccessful, Cabin Baby will be filled with brine and abandoned. A companion hole, Cabin Baby-2, will then be drilled to the bottom of the Ford Shale. This hole will be sited on an extension of the existing Cabin Baby pad. The decision to drill a new hole rather than attempting to deviate the existing Cabin Baby is based on concern about the capability to emplace and retrieve, through a deviated hole, the 15-to-20-foot packer strings that will be used in hydrologic testing. In addition, there is concern about the hydrologic reliability of a plug newly emplaced above/within "trash", ie, whether or not the presence of this hole would affect the results of hydrologic testing. Since Sandia has an ongoing contract with an earth mover, responsibility for both hole siting and pad preparation will be taken by Sandia.

Several specific points and options must be kept in mind in the possible drilling of Cabin Baby-2:

1. The intent would be to minimize coring in the upper part of Cabin Baby-2. Sandia is presently drilling hole H-11 (hydrology) approximately one mile from the Cabin Baby pad. Drilling there should be completed before the Cabin Baby site is occupied. The option must be retained, depending upon results in H-11, to take core at the following depths/stratigraphic locations: a) across the Dewey Lake-Rustler contact; b) within the Magenta dolomite; c) within the Culebra dolomite; and d) across the Rustler-Salado contact.
2. Regardless of whether or not the Rustler is cored, the intent would be to take approximately 25 feet of core at/across each of the major stratigraphic contacts (anhydrite/halite) within the Castile Formation. We do not expect to encounter pressurized brine in either Cabin Baby or Cabin Baby-2; nonetheless, prudence dictates that a blow-out preventer be used during drilling of the Castile in Cabin Baby-2.
3. We would want 100% core from the top of the Bell Canyon to the Bottom of the Ford Shale Member. Analysis of this core would aid greatly in understanding of the material and hydrologic properties of the upper portion of the Bell Canyon Formation near the WIPP, both above and immediately below the "Bell Canyon aquifer".
4. The initial assumption is that Cabin Baby-2, if needed, should be drilled such that 5 1/2" I.D. casing can be set to the Rustler-Salado contact. TSC will provide this casing, or will purchase equivalent casing to replace same if it must be taken from the Sandia "porta-camp" during drilling. TSC will also perform an informal survey to determine the likelihood of successful drilling/testing in a "slim" hole at Bell-Canyon depths.
5. As soon as possible after completion of drilling, Cabin Baby-2 would be geophysically logged by the USGS. It is anticipated that a "normal" suite of logs, including density, resistivity, gamma, gamma-gamma, neutron, sonic, and caliper logs would be run. In addition, we would log at least part of the hole using the acoustic televiewer. We anticipate that this logging operation would take two or three days.

6. Drilling should be done using a brine/mud that is tagged with a suitable tracer, ie, one that can be detected using "on-site" analysis. This is required in order to allow later distinction between formation waters and drilling fluids.

7. Immediately after completion of logging, a meeting would be convened, at which USGS, with assistance from SNL and TSC, would select the intervals to be hydrologically tested within the Bell Canyon. Because of their past criticism of intervals omitted from testing within the Bell Canyon, a representative of the NM/EEG would be invited to attend this meeting.

B. HYDROLOGIC TESTING AND WATER SAMPLING

A detailed test plan for hydrologic testing in Cabin Baby or Cabin Baby-2 will be provided to TSC during the week of 8/1/83. A summary of the testing requirements is given here, hopefully in sufficient detail to allow cost estimation.

I. Drill-Stem Testing

We anticipate doing drill-stem tests or modified drill-stem tests in from 2 to 5 zones within the Bell Canyon that are expected to be "permeable". This testing must be carried out with consideration of possibly extending "flow" times in relatively tight zones. We expect testing to require approximately three days for each sand tested, with the resultant total time ranging from 6 to 15 days. However, the option must be retained, based on initial test results, of lengthening the flow time for each drill-stem test. We recommend that drill-stem testing be carried out using 2 3/8" tubing (to be purchased by TSC), and that TSC contract Lynes, Inc. for a "triple" tool, which allows pressure monitoring both below and above the packed-off interval, as well as within it.

The drill-stem testing will allow estimation of both static downhole fluid pressures and hydrologic properties in the permeable zones tested.

II. Fluid Sampling During Drill-Stem Testing

A fluid sample will be collected as carefully as possible at the end of each drill-stem test. The possibility of improving the quality of fluid analyses by allowing each packed-off zone to flow before the initiation of drill-stem tests should be considered.

The fluid samples collected will allow preliminary calculation of estimated fluid pressures as a function of height above the points of pressure measurement. This information is required for calculation of directions of fluid movement in the event of a breach connecting the Bell Canyon and Rustler "aquifers".

III. Slug-Withdrawal or Pressure-Pulse Testing

We will require that at least one slug-withdrawal or pressure-pulse test be carried out in each selected zone. This test will provide a second estimate of in situ hydrologic properties. Sandia has the equipment necessary for these tests,

and will make this equipment available. We estimate that the time required for this testing will be 1 day per zone tested. The total time required for this testing should, therefore, range from 2 to 5 days.

IV. Fluid Sampling - Sampling Chamber

We do not, in advance, place great confidence in the quality of fluid analyses made during drill-stem testing. Therefore, we will want to reserve up to three days for attempts to sample formation fluids from the selected "permeable" zones using a downhole sampler that Sandia will provide. This apparatus consists of a vacuum cylinder with portals that can be opened and closed with a solenoid. The strategy will be to place the cylinder opposite each of the "permeable" zones and collect a sample, after reducing the fluid column in the hole sufficiently to assure that fluids will enter the hole from the Bell Canyon. The capability for analysis of the tracer used in the drilling fluid at the surface is required, in order to determine the level of contamination, if any, of each sample.

V. Fluid Sampling - Straddle Packers

We anticipate that neither samples collected during drill-stem tests nor those collected using the sample chamber will be of sufficiently high quality to provide adequate confidence in fluid densities and compositions, and, hence, in calculated directions of fluid movement during the intentional interconnection of Bell Canyon and Rustler. We therefore anticipate that it will be necessary to sample formation fluids from the Bell Canyon using straddle-packer assemblies. We recommend that TSC obtain 10 these assemblies from Lynes, Inc. In order to allow sufficient flow time for collection of each sample, we recommend that approximately 1.5 days be allowed per zone for collection of samples. The option must be retained to extend this time if necessary. If, of course, analysis indicates that samples taken during either the drill-stem tests or using the sample chamber are not appreciably contaminated with drilling fluids, this step of sampling can be deleted.

C. Temporary Abandonment of Hole.

At the completion of hydrologic testing in the Bell Canyon, the hole will be abandoned until testing of the Rustler hydrology by Sandia can begin. Accordingly, TSC should purchase a bridge packer from Lynes, for emplacement at a depth to be determined after logging and testing of the hole.

ARL:6331:arl

Distribution:

6330 - W. D. Heart
6331 - G. E. Barr
6331 - D. J. Borns
6331 - D. D. Gonzalez
6331 - S. J. Lambert

APPENDIX B
FIELD OPERATIONS PLAN

THE FOLLOWING WORK PLAN HAS BEEN
REVIEWED AND APPROVED FOR USE

FIELD OPERATIONS PLAN⁽¹⁾
CABIN BABY-1 BOREHOLE RE-ENTRY AND TESTING PROGRAM

REVISION 1

PREPARED BY

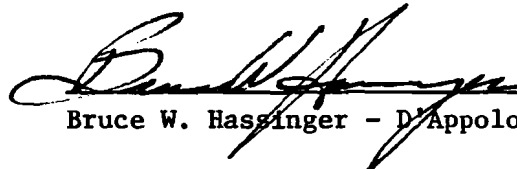
 DATE 11/4/83
Bruce W. Hassinger - D'Appolonia

APPROVED BY
QUALITY ASSURANCE

 DATE 11/4/83
Richard A. Lundstrom - D'Appolonia

APPROVED BY COG.
PROJECT MANAGER

 DATE 11/4/83
Joseph K. Register - TSC/D'Appolonia

APPROVED BY
TSC QUALITY ASSURANCE MANAGER

 DATE 11/7/83
John E. McClure - TSC/Westinghouse

(1) This plan is a working document to provide overall guidance for the field geotechnical activities. Its recommendations are subject to modification according to the actual field conditions and further analysis of the technical issues. This plan will be periodically revised and updated as required.

BELL CANYON HYDROLOGIC TESTING PROGRAM PLAN
CABIN BABY-1 HOLE

1.0 INTRODUCTION

This work plan outlines the objectives and scope of work for fishing, drilling, and hydrologic testing at the Cabin Baby-1 hole in Section 5, T23S, R31E, in Eddy County, New Mexico. The hole is located within the WIPP (Waste Isolation Pilot Plant) site near the south edge of the site. The hole was drilled as a hydrocarbon exploration hole and was turned over to the U.S. Department of Energy (DOE) after it was found to be a "dry hole." Testing in this borehole is being conducted for the DOE as part of the ongoing site characterization activities for the WIPP.

This plan provides overall guidance for the field activities. Modification can be expected with adjustment to actual field conditions and further analysis of technical issues. This plan will be periodically revised and updated as required.

2.0 OBJECTIVES

The objectives of this testing program are to:

- Provide data on the hydrologic properties, including hydrostatic head potential of selected permeable sand zones in the Bell Canyon Formation.
- Provide representative fluid samples from selected permeable zones in the Bell Canyon Formation which will be used to determine fluid composition and density.

These data will be used to refine calculations of the direction of fluid movement should the Bell Canyon and Rustler formations ever be interconnected. If the fluid flow direction is found to be downward, the data may be used to estimate Bell Canyon flow velocities and travel times. If the flow direction is found to be upward, the data may be used to calculate potential flow rates into the Rustler Formation.

3.0 ORGANIZATION

Direction of field operations and technical matters will originate with the WIPP Technical Support Contractor (TSC) under the supervision of J. K. Register of D'Appolonia and C. C. Little of Westinghouse Electric Corporation. Service contracts, including drilling, coring, and geophysical logging, as well as additional support services, will be let and administered by Westinghouse Electric Corporation. Contracts for mud and other drilling support services will be administered by Salazar Brothers Drilling, Inc. D'Appolonia is not anticipated to let or administer any additional service contracts.

The hydrologic testing program is under the direction of R. L. Beauheim, Hydrogeologist with D'Appolonia. Identification of stratigraphic features, core and cuttings logging, and other geologic interpretations will be provided by D'Appolonia geologists under the direction and supervision of Mr. Beauheim.

Assistance in the supervision of fishing, drilling, and testing operations will be provided by R. S. Popielak, Project Supervisor and R. L. Olsen, Senior Project Geochemist, both with D'Appolonia, and R. L. Oinonen, full-time drilling supervisor and consultant to D'Appolonia, on an as-needed basis.

Quality control on day-to-day operations will be administered by Mr. Beauheim. The overall Quality Assurance program for the TSC is the responsibility of J. E. McClure of Westinghouse. Field audits and technical and procedural reviews, however, will be provided by R. Lundstrom and other members of D'Appolonia's Quality Assurance staff. Appendix A presents the Quality Assurance Plan for this program.

4.0 PRESENT HOLE CONDITIONS

The existing data on the Cabin Baby-1 hole are sparse. The hole was drilled in 1974-1975 to a reported depth of about 4150 feet. The hole is cased to a depth of about 650 feet (just below the Rustler-Salado contact) with 13-3/8-inch casing, and is 12-1/4-inch open hole to at

least a depth of 3400 feet. A caliper log by Dresser Atlas indicates a hole diameter of about 9 inches below about 3950 feet. When Sandia National Laboratories (Sandia) reentered the hole in July 1983, they were unable to get below about 3400 feet due to a blockage. Sandia speculates that the blockage may be wireline or cable, perhaps on top of a bridge plug, grout plug, or shelf created by the hole diameter reduction. Sandia left the hole filled with brine/mud to the top of casing which should have created a hydrostatic head at the bottom of the well considerably in excess of that anticipated to exist in the Bell Canyon Formation. The fact that the fluid level in the well is declining only very slowly may indicate that the Bell Canyon is hydraulically isolated from the upper part of the hole, hence Sandia's speculation about the presence of a plug. The slow decline, however, could be the result of a mud cake on the hole wall at Bell Canyon depths.

Data on permeable zones in the Bell Canyon have been derived from drill-stem tests (DST's) performed in AEC-7, AEC-8, and ERDA-10. Tested zones have included the Lamar Member, the Ramsey Member and some pre-Ramsey sands. As described in Mercer (1983), the hydraulic conductivities of various zones in the Bell Canyon range from 2×10^{-6} to 5×10^{-2} ft/day (7×10^{-10} to 2×10^{-5} cm/sec). The flow periods of the DST's ranged from 10 to 480 minutes, and the buildup periods ranged from 60 to 748 minutes. Measured fluid densities ranged from 1.060 to 1.165 g/cc. Static fluid levels in Bell Canyon wells typically reach the elevation of the upper Rustler Formation.

5.0 HOLE REENTRY

Prior to fishing, the drilling contractor plans to reenter the hole using a 7-7/8 to 9-inch rotary bit to clean the hole above the lodged obstruction and to tag the top of the obstruction. At this point the contractor plans to use a fishing consultant to determine the nature of the obstruction and to direct the fishing operation. These operations

will also be observed by a D'Appolonia/TSC drilling supervisor and clear the hole.

Based on Sandia's observations of the nature of the lodged obstruction, the larger rig designated for this operation should be able to pull the obstruction. Fishing tools will probably consist of coil-type overshots that will hook the fish should it be wireline or cable as speculated.

If a plug is encountered, a reasonable effort will be made to determine the nature of the plug. The occurrence of a plug in the hole will seriously affect the feasibility of testing in the well due to the indeterminable amount of cement invasion into the aquifer. If a plug is present or if removal of the obstruction in the hole seems impossible, consideration should be given to drilling a new hole.

If a plug is not encountered, the fishing operation is successful, and the total depth (T.D.) is tagged, the hole will be cleaned and geophysical logs will be run in the lower part of the hole (about 3400 feet to T.D.) by a geophysical logging subcontractor to determine if the pre-Olds sandstones (Hays sandstone) of the Bell Canyon Formation has been penetrated and to determine hole diameter and wall condition. The following geophysical logs will be run at this time:

- Natural Gamma
- Compensated Neutron Porosity
- Neutron Density
- Caliper

If the Hays sandstone is penetrated and the hole walls are suitable for setting packers, no drilling will be required and the testing will proceed as outlined below.

If the geophysical logs indicate that the Hays sandstone was not penetrated, the hole will be extended about 120-180 feet using conventional rock coring techniques. The core diameter will be 4 inches and the hole diameter about 7-7/8 inches. The hole will then be reamed to the

diameter of the existing hole. A blow-out preventer will be used during hole deepening and H₂S gas monitors will be installed near the drilling rig platform and at the mud pit.

The total depth of the hole will then be geophysically logged by USGS or a commercial firm as outlined below.

6.0 TESTING PROGRAM

The following testing plan is based on the assumption that no insurmountable difficulties are encountered during restoration of the Cabin Baby-1 hole to its original total depth and that the condition of the hole does not interfere with the testing. If a new hole is drilled, testing will also follow the plan outlined below.

The testing program presented in this plan is, in general, responsive to the "Draft Scope of Work for Drilling and Testing of 'Cabin Baby,' Sec. 5, T23S, R31E - Phase I (DMG)" developed by Sandia National Laboratories and presented to the TSC on July 27, 1983. The testing program will consist of the following efforts:

- Observations during fishing. This will include monitoring down-pressure, fishing tools used, and pulling effort.
- Observations during drilling. This will include at a minimum monitoring of the mud balances, rate of drilling progress, gas presence.
- Geophysical logging. This will facilitate the determination of the contacts between porous, hence potentially water-bearing, strata and impermeable confinements. This information will be instrumental in detailed elaboration of the drill-stem testing program.
- Drill-stem testing (DST). Testing will be performed in zones of the Bell Canyon Formation indicated from geophysical logs as potentially permeable strata.
- Water quality sampling. Water samples will be extracted from tested horizons by means of swabbing the fluid from the 2-3/8" tubing after

completion of a DST sequence. In addition to swabbing, the samples may be collected with a downhole fluid sampler.

A detailed discussion of testing procedures planned for the Cabin Baby-1 well program is presented below.

7.0 DRILLING

During deepening of the Cabin Baby-1 well, the following information will contribute to a better understanding of the hydrological systems of interest.

- Monitoring of the drilling rate. Generally, prolific aquifers are drilled faster than "tight" strata. This results from relatively loose matrix, higher porosity, and often higher pore pressure.
- Monitoring of mud balance. Cabin Baby-1 is not expected to intercept a flowing artesian aquifer. However, such an aquifer could be easily detected by an increase in mud volume.
- Gas monitoring. The Bell Canyon is known to produce gases, primarily hydrocarbons, in some parts of the basin. The presence of gas in out-flowing mud may be an indication of a penetrated aquifer.

The Cabin Baby-1 hole deepening will be done in the presence of hydrologists and geologists experienced in deep well drilling and knowledgeable about hydrologic systems which may be present at the site.

8.0 GEOPHYSICAL LOGGING

As soon as the total depth is reached and the hole is cleaned and conditioned, a suite of geophysical logs must be run. This suite should include the following (interval to be logged and anticipated logger are noted):

- Dual Laterolog - Measures deep and shallow resistivity; provides information on lithology and mud invasion (from about 200' above top of Bell Canyon to T.D., commercial logging firm).

- Natural Gamma - Measures natural gamma radiation emitted by rock. Used to identify clays and shales (entire open hole, USGS).
- Compensated Neutron - Measures density of hydrogen atoms (concentrations) in the formation; used to estimate porosities (entire open hole, USGS).
- Neutron Density - Measures density of electrons in the formation; used to estimate bulk densities and porosities (entire open hole, USGS).
- Borehole Compensated Sonic - Measures sonic travel times; used to detect fractures and estimate porosities (entire open hole, USGS).
- Three-Arm Caliper - Measures hole diameter; used to calibrate other logs and to select packer seating depths (from about 200' above top of Bell Canyon to T.D., USGS).
- Borehole Deviation - Measures deviation of hole from true vertical; used to calculate true elevations of contacts (will be run after all testing is completed, entire hole, commercial logging firm).
- Acoustic Televiewer (will be run after all testing is completed) - Converts attenuation of sonic signal to "picture" of borehole wall; used to identify fractures and their orientation (may be used if presence of fractures is suspected, entire open hole, USGS).

All logging will be supervised by D'Appolonia geologists or hydrologists to ensure that log quality is adequate. Once complete logs of the hole are obtained, the intervals to be tested will be selected jointly by the DOE, TSC, Sandia, USGS, and the NM Environmental Evaluation Group (EEG). We estimate that a maximum of five zones will be selected for DST's.

9.0 DRILL-STEM TESTS

Drill-stem testing equipment, consisting of a straddle packer assembly, J-slot tool, transducers above, below, and between the packers, and a

conducting wireline, will be provided by Lynes, Inc. A computerized data acquisition and processing system will also be employed. Two sets of computer equipment will be used. One set will be used continuously for data acquisition, and the other set will be used for on-site data processing and analysis and will also serve as backup equipment in case one or more components in the first set malfunction.

Following selection of the intervals to be tested, drill stem tests will be performed working from the lowest interval up. The packer separation will be adjusted as necessary to achieve the desired straddling. After reaching the desired depth, the packers will be inflated and tested by pushing or pulling the 2-3/8 inch tubing to ensure that they have seated properly. The water present in the tubing will then be swabbed out. Prior to the actual DST, the formation hydrostatic pressure will be monitored until stable. The time of monitoring will depend on formation permeability and amount of overpressure due to packer inflation.

The actual DST begins with opening a shut-in tool which allows the water in the straddled interval to enter the tubing. Due to the large pressure differential (between the tubing and the straddled interval), water under the initial static formation pressure flows rapidly towards the borehole and up the tubing string. This is the first flow period (FFL). This period begins with a drop in pressure from static (shut-in tool closed) to a pressure corresponding to the weight of the water remaining in the tubing (after swabbing) above the transducer. As water rises up the tubing string, the pressure within the straddled interval increases, reducing the pressure differential and thus, the flow velocity.

After a minimum recovery of thirty percent of available differential pressure during the first flow (FFL), the shut-in tool will be closed, stopping the flow of water up the tubing. This is the beginning of the first pressure buildup period (FBU). The formation will be allowed to recover in the first pressure buildup period for about three times as long as the first flow period, or longer if necessary to achieve a

stable pressure. The shut-in tool will then be reopened to initiate the second flow period (SFL). The water level in the tubing will not have changed since the end of the first flow period. The second flow period will last until about sixty percent of the available pressure differential is reached. Again, the shut-in tool will be closed and the second buildup period (SBU) will begin. This buildup period will continue for a period not less than than three times the second flow period. A third flow period and buildup period will be conducted, if feasible, to verify the accuracy of the previous tests. The feasibility of such a test will depend on the likelihood of over-stressing the aquifer (which should be avoided) and the potential of obtaining useful information for verification purposes.

These four periods, FFL, FBU, SFL, and SBU, generally constitute a single complete DST. Data obtained from a third flow period and buildup period, if performed, will be used to verify the results of the previous tests. Depending on the observed responses, test durations may be either lengthened or shortened in the field.

Following the conclusion of each DST, the fluid will be swabbed out of the tubing and a long-term slug test will be performed. Prior to conducting the slug test, a simple calculation of the expected duration of the slug test should be performed based on the DST results. If the calculation indicates that the expected duration of the test (to reach 80-90% of the pressure lost) is greater than 48 hours, consultation with the USGS and SNL will be necessary. When the pressure has stabilized during the SBU, the shut-in tool will be opened. As with the first flow period (FFL) of a DST, the pressure on the transducer will initially drop from static reservoir pressure to a pressure corresponding to the weight of the remaining fluid in the tubing above the transducer. As water rises up the tubing string, the pressure on the transducer will rise. The slug test will consist of monitoring the pressure rise. Ideally, the pressure rise should be monitored until 80-90% of the pressure lost is recovered. Application of the "modified" slug test (Bredehoeft and Papadopolus, 1980; Neuzil, 1982) is not considered for

this program. These methods require injection of fluid under an imposed high head. This procedure would complicate water quality sampling.

Water Quality Sampling

Water quality samples will be collected by swabbing from each tested interval; this method has been used in the past with success. Following is the proposed procedure for sample collection.

Upon completion of the second buildup period and prior to the removal and re-setting of the DST instrumentation, the shut-in valve will be opened and formation fluid swabbed out of the drill stem. Swabbing will proceed until (a) parameters such as pH and EC (electroconductivity) stabilize or (b) three volumes of the testing pocket (space between packers) are evacuated by swabbing. If the field-measured parameters show stable values, one water sample will be collected for analysis at the end of swabbing. If the parameters continue to vary, at least two samples will be collected. One sample will be collected after three volumes of the testing pocket are evacuated and one at the end of swabbing; other "intermediate" samples may be collected. Samples will be filtered, labeled, and stored in an ice-filled box until analyzed in the D'Appolonia laboratory in Pittsburgh.

The potential exists for samples extracted by swabbing to be contaminated by drilling fluid. To determine the concentration of the drilling fluid in the sample, the tracer method will be employed.

Sodium thiocyanate will be added to the drilling mud for use as a tracer. Thiocyanate is detectable by colorimetric methods to concentrations of 1 mg/l (see Appendix B for analytical procedures). Enough sodium thiocyanate will be added to the mud to result in a concentration of approximately 100 mg/l. This will permit easy detection of the thiocyanate in the mud and distinguishing between drilling fluid and formation waters. The colorimetric method can be performed relatively easily and rapidly in the field. To eliminate the potential of sample

contamination with metals present in commonly used rod dope, a non-metallic organic grease/seal compound will be used on all joints of 2-3/8 inch tubing and the DST tool.

DATA ANALYSIS

The analyses of the DST data are to produce answers to the following questions:

- What is the undisturbed hydrostatic pressure in the tested aquifers?
- What are the hydraulic properties of the tested aquifers?

The answer to the first question will be obtained by monitoring of the static pressure prior to the initiation of the first flow period (FFL). Checking of this information is routinely done by extrapolation of the Horner plot (DP-DT method) to infinite time. The analytical methods to define the aquifers' hydraulic properties are discussed below.

Flow Period Data Analysis

The flow period data and slug tests will be analyzed by a method first presented by Cooper et al. (1967). The method is used for calculating the hydraulic conductivity and storage coefficient of a homogeneous, isotropic artesian aquifer of uniform thickness which is fully penetrated by a well. To begin the flow period, a hydraulic gradient is established around the well by instantaneously removing from or injecting into the well a known amount of water. The problem is described mathematically by:

$$\frac{\partial^2 h}{\partial r^2} + \frac{1}{r} \frac{\partial h}{\partial r} = \frac{S}{T} \frac{\partial h}{\partial t}$$

where:

h = hydraulic head at radius r , and time t .

r = radius from well center

t = time

S = formation storage coefficient

T = formation transmissivity

This equation describes nonsteady, radial flow of ground water.

The solution to this equation utilized for analysis of flow period data is presented in the form of curves of $\frac{P(t)-P_s}{P_s-P_i}$ versus the dimensionless time parameter $\beta = Tt/r_c^2$ for each of several values of $\alpha = r_s^2 S/r_c^2$.

where:

$P(t)$ = head or pressure data as a function of time

P_s = static head or pressure

P_i = initial head or pressure (when flow begins)

r_s = radius of borehole

r_c = inside radius of tubing string

The use of these type curves is similar to the Theis graphical method of pumping test analysis. A plot of the quantity $[P(t)-P_s/P_s-P_i]$ versus t is made on semilogarithmic paper of the same scale as the type curves. The type curves are then placed over the test data and translated horizontally (with the horizontal axes coincident) until a best fit is achieved. In this position a match point is chosen, and the coordinates of this point, α and β , are read from the type curve, and t is read from the data plot. The values of transmissivity (T) and storage coefficient (S) are then calculated from the following rearrangements of the equations just presented using the coordinates of the match point.

$$T = \frac{\beta r_c^2}{t}$$

$$S = \frac{\alpha r_c^2}{r_s^2}$$

Buildup Period Data Analysis

The buildup period data will be analyzed using a method developed by Horner (1951). Horner's solution is:

$$H(t) = H_s - \frac{2.3q}{4\pi T} \log \frac{t + \Delta t}{\Delta t}$$

where:

$H(t)$ = head inside the well bore at time t

H_s = static head

q = production rate of previous flow period (assumed to be constant)

t = time since shut in (buildup time)

T = test zone transmissivity

Δt = length of previous flow period (all consistent units)

This equation is solved graphically by plotting $H(t)$ versus $\log \frac{t + \Delta t}{\Delta t}$, drawing a straight line through the data, and measuring the change in $H(t)$ on this line over one log cycle. The above equation then reduces to:

$$T = \frac{2.3q}{4\pi \Delta h}$$

where Δh = change in head on the line over one log cycle. T is then calculated.

The semilog plot used in the Horner analysis can also be used to estimate the static formation pressure head. The axis where $\log \frac{t + \Delta t}{\Delta t} = 1$ represents infinite recovery time, and the value of $H(t)$ at this time should equal H_s unless the reservoir has been permanently depleted.

REFERENCES

- Bredehoeft, J. D. and I. S. Papadopoulos, 1980, A Method for Determining the Hydraulic Properties of Tight Formations: Water Resources Research, v. 16, no. 1, pp. 233-238.
- Cooper, H. H., J. D. Bredehoeft, and I. S. Papadopoulos, 1967, Response of a Finite-Diameter Well to an Instantaneous Charge of Water: Water Resources Research, v. 3, no. 1, pp. 263-269.
- Horner, D. R., 1951, Pressure Buildup in Wells: Proc., Third World Pet. Cong., The Hague, Sec. II, pp. 503-523.
- Mercer, J. W., 1983, Geohydrology of the Proposed Waste Isolation Pilot Plant Site, Los Medanos area, Southeastern New Mexico: U.S. Geol. Survey Water-Resources Investigations Report 83-4016, 113 pp.
- Neuzil, C. E., 1982, On Conducting the Modified "Slug" Test in Tight Formations: Water Resources Research, v. 18, no. 2, pp. 439-441.

D'APPOLONIA QUALITY ASSURANCE PLAN
REVISION 0
CABIN BABY-1 WELL
DRILLING AND TESTING PROGRAM

1.0 OBJECTIVE

For the drilling and testing activities performed by D'Appolonia at the Cabin Baby-1 Well, applicable portions of the D'Appolonia Quality Assurance Program shall be applied to provide an internal means for control and review so that the work performed is of the highest professional standards. Applicable portions of the Quality Assurance Program are:

- Subsurface investigation and sampling
- Sample identification and control
- Field testing and associated documentation
- Equipment calibration
- Analysis documentation and verification
- Nonconformance documentation
- Records administration
- Quality assurance auditing

In addition to the above, requirements specified by the Technical Support Contractor (Westinghouse) shall be implemented.

2.0 ORGANIZATION

Technical and field operations for the project will be directed by J. K. Register of TSC/D'Appolonia. Supervision of field drilling, geologic logging, hydrological testing, and subsequent interpretations will be provided by R. L. Beauheim of TSC/D'Appolonia.

The D'Appolonia Project Staff shall be responsible for the day-to-day quality control activities. It is the responsibility of the Project Staff to implement pertinent quality requirements as normal operating procedure.

Quality assurance for the Field Program will be performed under the cognizance of the TSC Quality Assurance Manager, John McClure, of TSC/Westinghouse. Geologic and hydrologic quality assurance activities will be supervised by F. D. Carter, Director of Quality Assurance for TSC/D'Appolonia. These activities will be administered by R. A. Lundstrom and, as necessary, other members of the TSC/D'Appolonia Quality Assurance Group. This group will be responsible to administer quality assurance for activities which are controlled by the TSC. Any other major project participants (USGS, Sandia Labs, etc.) will be responsible for their own quality assurance.

3.0 PROJECT CONTROL

Control and review of project activities shall be accomplished through implementation of the following items:

- Inspection by the Project and/or Quality Assurance Group of TSC-subcontractor supplied equipment. Documentation of the inspection will be added to the project files. Project personnel will continuously review the performance of TSC-subcontractors and document any deficiencies.
- Review by the Quality Assurance Group of field work plans. Evidence of review will be indicated by signing and dating all review copies.
- Discussions between field personnel and the Quality Assurance Group of quality requirements to be implemented as part of day-to-day site activities. These discussions will be held prior to the start of field work and resulting documentation added to the project files.
- Use of documented or referenced standard procedures and/or work plans for quality related activities (e.g., logging, testing, sample identification and control, data reduction documentation and verification, records administration, and quality assurance auditing).
- Use of qualified Project Staff personnel (e.g., hydrologists and geologists) to perform core logging and in situ testing activities.
- Formal calibration and documentation by the Project Staff of all D'Appolonia measuring and test equipment. Calibration shall assure that equipment is of the proper type, range, accuracy, and precision to provide data compatible with desired results. Calibration records for D'Appolonia and appropriate TSC-subcontractor equipment will be added to the project files.
- Complete documentation by the Project Staff of field operations, any testing and data reduction, and office analyses.
- Formal independent verification by the Project Staff (e.g., hydrologists and geologists) of all data reduction and analyses.

- Documentation by the Project Staff of variances from project procedures and work plans. Included as part of the documentation will be the approval of supervisors, project management, and quality assurance.
- Appropriate control and retention by the Project Staff and Information Services personnel of all project related records, both in the field and the D'Appolonia records administration system. At the conclusion of the work, copies of records, as requested, will be provided to the TSC Master Records Center.
- Performance of field and project and report audits by the Quality Assurance Group using standard D'Appolonia procedures. Field auditing will include rock coring and logging, sample identification and control, hydrologic testing and monitoring, field testing, and associated documentation. Project and report audits will be performed for the basic data report on drilling and hydrologic testing at the Cabin Baby-1 Well. Each project and report audit will cover the report text, tables, and figures; as well as all project work providing input to the report. All audit results shall be formally documented and sent to D'Appolonia management for review. The results will also be provided to the TSC Quality Assurance Group.

APPENDIX B
THIOCYANATE ANALYTICAL PROCEDURE

SCOPE AND APPLICATION

This method is for the determination of thiocyanate (CNS^-) in waste water.

When wastewater containing thiocyanate (CNS^-) is chlorinated, highly toxic cyanogen chloride (CNCl) is formed. At an acidic pH, ferric ion (Fe^{3+}) forms an intense red color with CNS^- , which is suitable for colorimetric determination.

APPARATUS

1. 50 ml volumetric flasks
2. pH paper
3. Spectrophotometer - Lambda 3
4. Filtering apparatus with 0.45 μ membrane filter

REAGENTS

1. Ferric nitrate solution: Dissolve 50 g $\text{Fe}(\text{NO}_3)_3$ in 500ml DI H_2O . Add 25 ml conc. HNO_3 and dilute to 1 liter.
2. Nitric acid - HNO_3 1:1
3. Standard thiocyanate solution: Dissolve 1.673 g potassium thiocyanate (KCNS) in DI H_2O and dilute to 1000 ml; 1 ml = 1 mg CNS^- .
4. NaOH - Sodium hydroxide
5. H_2O_2 - Hydrogen Peroxide
6. FeSO_4 - Ferrous sulfate

PROCEDURE

1. If hexavalent chromium is known to be in sample, it is removed by adding ferrous sulfate (FeSO_4) after adjusting to pH 1 to 2, with nitric acid (HNO_3). Raising the pH to 9 with 1N sodium hydroxide

(NaOH) precipitates Fe (III) and Cr (III), which are then filtered out.

2. Add two drops of H_2O_2 to a 25 ml sample in 50 ml volumetric flask.
3. Adjust pH to pH 5 to 7 by adding 1:1 HNO_3 dropwise. Check with pH paper.
4. Add 5 ml $\text{Fe}(\text{NO}_3)_3$ solution.
5. The pH should be between 1 and 2.
6. Check with pH paper, adjust with 1:1 HNO_3 if necessary.
7. Dilute to volume with DI H_2O and shake well.
8. Measure sample absorbance at 480 nm using a DI H_2O blank on the Lambda 3 spectrophotometer.
9. Prepare a standard curve plotting absorbance against CNS^- concentration in μg per 50 ml volume.
10. Standard should range from 50 to 500 $\mu\text{g CNS}^-$.
11. Run standards through same procedure as samples.

CALCULATION

$$\text{mg CNS}^-/\ell = \frac{\mu\text{g CNS}^-}{\text{ml sample}}$$

REFERENCE

Standard Methods for the Examination of Water and Wastewater, 15th Edition, 1980, Method 315B.

APPENDIX A

THE FOLLOWING
PROJECT QUALITY ASSURANCE PLAN
HAS BEEN REVIEWED AND APPROVED FOR USE

D'APPOLONIA QUALITY ASSURANCE PLAN
CABIN BABY-1 WELL
DRILLING AND TESTING PROGRAM

REVISION 1

APPENDIX C
BOREHOLE HISTORY

CABIN BABY-1
HOLE HISTORY

NOTE: Cabin Baby-1 was previously drilled using a cable tool or percussion type drilling rig to a total depth of 4150'. This was accomplished between May 31, 1974 and February 8, 1975. All depths were recorded from ground level (GL) during this period. The 1974-75 hole history is repeated in the form received. No attempt has been made to edit or correct it.

5-31-74	Spudded at 10 p.m. to depth of 6'
6-1-74	Drilling 6' to 20'
6-2-74	Drilling 20' to 35'
6-3-74	Drilling 35' to 50'
6-4-74	Drilling 50' to 60'
6-5-74	Drilling 60' to 70'
6-6-74	Drilling 70' to 80'
6-7-74	Reaming from 12 1/4" hole to 15"
6-8-74	Reaming from 12 1/4" hole to 15"
6-9-74	Reaming from 12 1/4" hole to 15"
6-10-74	Reaming from 12 1/4" hole to 15"
6-11-74	Drilling 80' to 90'
6-12-74	Drilling 90' to 100'
6-13-74	Drilling 100' to 110'
6-14-74	Drilling 110' to 120'
6-15-74	Drilling 120' to 130'
6-16-74	Drilling 130' to 145'
6-17-74	Drilling 145' to 160' Fishing
6-18-74	Fishing
6-19-74	Drilling 160' to 180'
6-20-74	Drilling 180' to 190' Picked up small stream of water at 190'; est. @ 1 gal. per min.; fluid @ 140'.
6-21-74	Drilled from 190' to 210'
6-22-74	Drilled from 210' to 235' (red clay); hole caving; mixed 9 sacks of mud gel
6-23-74	235' Hole filled in 45 ft.; cleaning out from 190 ft to 235 ft hole caving; mixed 11 sacks of mud gel

6-24-74 235' to 240' in red clay; cleaned out 35' cavings
 6-25-74 240' to 250' Cleaned out cavings
 6-26-74 Drilled 250' to 255' Cleaned out cavings
 6-27-74 Drilled 255' to 268' Cleaned out cavings - water level @ approx 140'
 6-28-74 Drilled 268' to 285' Hole caving; mixed 5 sacks gel
 6-29-74 285' Shut down
 6-30-74 Hole caving in shut down waiting on pipe
 7-1-74 Reaming hole in order to set 16" casing so that can drill through it; reamed 0-40'
 7-2-74 Reaming 40' to 100'
 7-3-74 Reaming 100' to 145'
 7-4-74 Reaming 145' to 170'
 7-5-74 Reaming 170' to 180'
 7-6-74 Reaming 180' to 195'
 7-7-74 Reaming and cleaning 195' to 210'
 7-8-74 Reaming 210' to 225'
 7-9-74 Reaming and cleaning out 225' to 235'
 7-10-74 Reaming and cleaning 230' to 235'
 7-11-74 Ran 235' of 16" casing in hole to drill through
 7-12-74 Cleaned hold from 235' to 285'; drilled from 285' to 295' red bed
 7-13-74 Drilled 295' to 305' in red clay; 305' to 310' in anhydrite
 7-14-74 Drilled 310' to 325' in anhydrite
 7-15-74 Drilled 325' to 340' anhydrite
 7-22-74 Fishing
 7-23-74 Fishing and drilling 425' to 430'
 7-24-74 Drilling and cleaning out 430' to 432'
 7-25-74 Drilling and cleaning out 432' to 440'
 7-26-74 Drilling and cleaning out 440' to 444'
 7-27-74 Off
 7-28-74 Off
 7-29-74 Drilling and cleaning out 444' to 447'
 7-30-74 Drilling and cleaning out 447' to 450'
 7-31-74 Drilling and cleaning out 450' to 455'. Depth corrected to 462' (afternoon)

8-1-74 Drilling 462' to 465' in anhydrite; hole caving bad; 7 sacks gel

8-2-74 Hole caving; mixed 9 sacks gel; cleaning out hole

8-3-74 Jarring on tools; jarred tools loose; cleaned hole; 4 sacks gel

8-4-74 Working on R.C. bearings

8-5-74 Off

8-6-74 Off

8-7-74 Drilling 465' to 475' Brown shale

8-8-74 Lost bit; layed down drilling tools

8-9-74 Picked up fishing tools

8-10-74 Fishing for bit

8-11-74 Fishing for bit

8-12-74 Fishing for bit; fished bit out of hole; ready to drill

8-13-74 Drilling 475' to 490'

8-14-74 Drilling 490' to 500'

8-16-74 Drilling 500' to 515' anhydrite

8-17-74 Cleaned out to bottom, stuck tools on bottom

8-18-74 Cut drilling line on top of tools; fished out tools, ready to drill

8-19-74 Drilled 515' to 530'

8-20-74 Drilled 530' to 538'

8-21-74 Drilled 538' to 550'

8-22-74 Drilled 550' to 555'

8-23-74 Drilled 555' to 558'

8-24-74 Drilled 558' to 560'

8-25-74 Cleaning out hole and fishing

8-26-74 Cleaning out hole and fishing

8-27-74 Drilled 560' to 565'

8-28-74 Drilled 565' to 575'

8-29-74 Drilled 575' to 585' in red shale

8-30-74 Drilled 585' to 590' in red shale
Drilled 590' to 595' in blue shale

8-31-74 Drilled 595' to 620' in blue shale

9-1-74 Drilled 620' to 645' in gray shale and anhydrite

9-2-74 Drilled 645' to 650' in gray shale; worked on hole and mixed mud; finished, conditioned hole; ready to run casing, waiting on pipe and casing tools

9-3-74 At 650' loaded casing out of Grave Yard; rigged up casers and ran 650' of 13 3/8" casing

9-4-74 Cleaned out to 650'; pulled 16" casing

9-5-74 Ran 20 jts. of 13 3/8"-71# casing set @ 650'. Cemented with 275 sacks of Trin. Lt. Wt. and 125 sacks Cl. C. & 300#-Cal. Chl. & 69# Celloflake

9-6-74 Waiting on cement; cut casing off; loaded out casing tools; moved 16" casing to corner of pad

9-7-74 Waiting on cement; repaired rig

9-8-74 Waiting on cement; repaired rig

9-9-74 Repaired rig

9-10-74 At 650' put heavier shaft in rig; trip to shop

9-11-74 Drilling out plug. Drilling cement from 545' to 560'

9-12-74 Drilling cement from 560' to 580'

9-13-74 Drilling cement from 580' to 605'

9-14-74 Drilling cement from 605' to 625'

9-15-74 Off

9-16-74 Drilling cement from 625' to 650'. Drilled from 650' to 660' in red clay.

9-17-74 Drilling from 660' to 710' in salt

9-18-74 Drilling from 710' to 745' in salt

9-19-74 Drilling from 745' to 795' in salt and shale

9-20-74 Drilling from 795' to 845' in salt and shale

9-21-74 Drilling from 845' to 900' in salt and shale

9-22-74 Rained out

9-23-74 Rained out

9-24-74 Tried to get into location but could not

9-25-74 Drilling from 900' to 950' in salt and shale

9-26-74 Drilling from 950' to 995' in salt and shale

9-27-74 Drilling from 995' to 1050' in salt and shale

9-28-74 Drilling from 1050' to 1110' in anhydrite and salt

9-29-74 Drilling from 1110' to 1180' in anhydrite and salt

9-30-74 Drilling from 1180' to 1250' in anhydrite and salt

10-1-74 Drilling from 1250' to 1350' in anhydrite and salt; set rope socket; jumped pin on drill stem; waiting on fishing tools

10-2-74 Fished out stem and bit and worked on rig

10-3-74 Drilling from 1350' to 1410' in anhydrite and salt; made up tools

10-4-74 Drilling from 1410' to 1440' in anhydrite and salt; repair on gas regulator

10-5-74 Drilling from 1440' to to 1460' in anhydrite and salt; rained out after four hours

10-6-74 Off

10-7-74 Drilling from 1460' to 1475' in anhydrite

10-8-74 Drilling from 1475' to 1495' in anhydrite

10-9-74 Drilling from 1495' to 1520' in anhydrite

10-10-74 1520' burned out bearing and spudding clutch of rig; repaired rig and waited on parts

10-11-74 Worked on rig; waited on parts

10-12-74 Worked on rig; waited on parts

10-13-74 Off

10-14-74 Couldn't get into location due to rain

10-15-74 Couldn't get into location

10-16-74 Worked on rig; waited on parts

10-17-74 Worked on rig; waited on parts; assembled spudding clutch and drilled from 1520' to 1525' in anhydrite

10-18-74 Drilling from 1525' to 1550' in anhydrite and salt

10-19-74 Drilling from 1550' to 1570' in anhydrite

10-20-74 Drilling from 1570' to 1600' in anhydrite

10-21-74 Drilling from 1600' to 1670' in anhydrite and salt

10-22-74 Drilling from 1670' to 1750' in anhydrite and salt

10-23-74 Drilling from 1750' to 1790' in anhydrite and salt

10-24-74 Drilling from 1790' to 1825' in anhydrite

10-25-74 Drilling from 1825' to 1865' in anhydrite

10-26-74 Drilling from 1865' to 1905' in anhydrite

10-27-74 Drilling from 1905' to 1935' in anhydrite; spliced on new sand line

10-28-74 Drilling from 1935' to 1985' in anhydrite and salt

10-29-74 Drilling from 1985' to 2035' in anhydrite and salt

WTSD-TME-020

10-30-74 Drilling from 2035' to 2085' in anhydrite and salt
10-31-74 Drilling from 2085' to 2150' in anhydrite and salt
11-1-74 Drilling from 2150' to 2160' in anhydrite; cut off 200' of
drill line
11-2-74 Drilling from 2160' to 2210' in anhydrite
11-3-74 Off
11-4-74 Drilling from 2210' to 2220' in hard white lime
11-5-74 Drilling from 2220' to 2235' in hard white lime
11-6-74 Drilling from 2235' to 2250' in hard white lime
11-7-74 Drilling from 2250' to 2280' in hard white lime
11-8-74 Drilling from 2280' to 2300' in hard white lime
11-9-74 Spooled on new drilling line; no footage
11-10-74 Off
11-11-74 Drilling from 2300' to 2350' in hard white lime
11-12-74 Drilling from 2350' to 2400' in hard white lime
11-13-74 Drilling from 2400' to 2450' in hard white lime
11-14-74 Drilling from 2450' to 2465' in hard white lime
11-15-74 Drilling from 2465' to 2485' in hard white lime
11-16-74 Drilling from 2485' to 2510' in hard white lime
11-17-74 Drilling from 2510' to 2535' in white lime
11-18-74 Drilling from 2535' to 2555' in white lime
11-19-74 Drilling from 2555' to 2570' in white lime
11-20-74 Drilling from 2570' to 2610' in white lime
11-21-74 Drilling from 2610' to 2680' in white lime
11-28-74 Drilling from 2900' to 2940' in white lime
11-29-74 Drilling from 2940' to 2995' in white lime
11-30-74 Drilling from 2995' to 3045' in white lime
12-1-74 Drilling from 3045' to 3100' in white lime
12-2-74 Drilling from 3100' to 3150' in white lime
12-3-74 Drilled from 3150' to 3200' in white lime
12-4-74 Drilled 3200' to 3235' in gray lime
12-5-74 Drilled 3235' to 3260' in gray lime
12-6-74 Drilled from 3260' to 3310' in gray lime
12-7-74 Drilled from 3310' to 3340' in gray lime

12-8-74 Drilled from 3310' to 3315' in gray lime; drilling stranded sand line; trip to yard for new sand line

12-9-74 Pulled off old sand line, spooled on new sand line

12-10-74 Drilled from 3310' to 3325' in gray lime; cleaning out

12-11-74 Drilled from 3325' to 3340' in gray lime

12-12-74 Drilling magneto cutting out on rig motor

12-15-74 Off, waiting for magneto for rig

12-16-74 Put magneto on motor; drilling salt and lime

12-17-74 Salt and lime streaks

12-18-74 Drilled from 3425' to 3455' anhydrite

12-19-74 Drilled from 3455' to 3485' anhydrite

12-20-74 Drilled from 3485' to 3510' anhydrite

12-21-74 Drilled from 3510' to 3530' anhydrite in lime

12-22-74 Drilled from 3530' to 3545' anhydrite in lime

12-23-74 Drilled from 3545' to 3565' anhydrite in lime

12-24-74 Drilled from 3565' to 3565' anhydrite in lime

12-25-74 Shut down

12-26-74 Drilled from 3565' to 3565' anhydrite in lime

12-27-74 Drilled from 3565' to 3580' anhydrite in lime

12-28-74 Drilled from 3580' to 3610' anhydrite in lime

12-29-74 Drilled from 3610' to 3635' anhydrite in lime

12-30-74 Drilled from 3635' to 3675' anhydrite in salt

12-31-74 Drilled from 3675' to 3715' anhydrite in salt

1-1-75 Drilled from 3715' to 3750' anhydrite in salt

1-2-75 Drilled from 3750' to 3785' anhydrite in salt

1-3-75 Drilled from 3785' to 3800' and 3800' to 3825' in anhydrite and lime

1-4-75 Drilled from 3825' to 3875' lime and anhydrite

1-5-75 Drilled from 3875' to 3910' lime and anhydrite

1-6-75 Drilled from 3910' to 3945' lime and anhydrite

1-7-75 Drilled from 3945' to 3985' lime and anhydrite

1-8-75 Drilled from 3985' to 4020' lime and anhydrite

1-9-75 Drilled from 4020' to 4030' lime and anhydrite

1-10-75 Fishing for drill tools

1-11-75 Fishing for drill tools

WTSD-TME-020

1-12-75 Fishing for drill tools
1-13-75 Fishing for drill tools
1-14-75 Fishing for drill tools
1-15-75 Fishing for drill tools
1-16-75 Run wire line
1-17-75 Fishing for wire line
1-18-75 Fishing for wire line
1-19-75 Fished out 20' of wire line
1-20-75 Fishing for tools
1-21-75 Fishing for tools
1-22-75 Fishing for wire tools
1-23-75 Fishing for tools and wire
1-24-75 Fishing for tools and wire
1-25-75 Fishing
1-27-75 Fishing for tools
1-28-75 Fishing for tools, and wire
1-31-75 Fished out prong of torgs
2-1-75 Fished out tools
2-2-75 Spliced Dorlc, lime layed down fishing tools
2-3-75 Cleaned out hole to bottom; drilling
2-4-75 From 4035' to 4045' lime gray; 4045' to 4070' lime black;
set socket
2-5-75 From 4070' to 4090' lime gray
2-6-75 From 4090' to 4125' lime gray; water 4095'
2-7-75 From 4125' to 4150' gray lime; logged well (hit Delaware
sand at 4170')
2-8-75 Still logging; rig released

NOTE:

Cabin Baby-1 was deepened to 4298.6' (below KB) for hydrologic testing by D'Appolonia (TSC) from August 12, 1983 through September 29, 1983. All depths reported were from kelly bushing elevation 8.0' above ground level (GL) unless otherwise noted.

8-12-83 Preparing drill pad, mud pits; installing equipment, pumps, tanks and piping
8-14-83 Rig and equipment ready for entry

- 8-15-83 Entered hole using 4-1/2" OD pipe with 7-7/8" rotary bit. Began circulating at 3423'; encountered small bridge at 3785'; hooked-up to kelly and pumped and rotated through bridge. Started drilling hole fill at about 4120'.
- 8-16-83 Circulated and advanced to 4159'. Action of drilling indicated undisturbed formation. Probably not cement plug as pH=7.0. Pulled and strapped pipe. Reentered and circulated and fished with magnet. Magnet picked up a few metal shavings. Rigged Dresser Atlas and entered hole for Neutron-Porosity (CN) and Gamma Ray (GR). Logs run to 4100'. Ran 4-Arm Caliper log. Began installing BOP. Three loads of brine hauled on site.
- 8-17-83 Completed BOP installation. Mixed mud for coring. Entered hole and circulated to clean hole. Touched top of formation at 4159' (measured from top of kelly bushing). Began coring after circulating for 2 hours. Coring rate was about 4-5 minutes/ft with 16,000 lbs. on bit. Completed coring at 4219', pulled and began to remove core.
- 8-18-83 Core removed and racked on pad (recovery 100%). Prepared core barrel for second run. Began coring at 4219'. Cored 4219' to 4279' with 14,000 to 16,000 lbs weight on bit. Removed and racked core run #2. Reentered hole and began core run #3 at 4279'.
- 8-19-83 At 4298' coring rate slowed from 2 min/ft to 8-10 min/ft. Drilling fluid pressure increased from 500 lbs. to 1000 lbs. Core engineer suggested bit may be damaged or soft formation may have blocked circulation. Pulled core barrel and performed geophysical logs. Dresser Atlas performed compensated neutron (CN), gamma ray (GR) (4097'-2100'), and 4-arm caliper logs. Review of geophysical logs showed sufficient depth for hydrologic testing. Rig was put on standby until Lynes DST equipment arrived.
- 8-20-83 Rig on standby awaiting arrival of testing equipment. Core photographs taken in Carlsbad office core library.
- 8-21-83 Rig on standby.
- 8-22-83 Rig on standby. Core was sealed and boxed in Carlsbad office core library.
- 8-23-83 Rig on standby. Core boxing, filing, and computer log-in forms completed in Carlsbad office core library.
- 8-24-83 Started to run in borehole for reaming with 9-7/8" bit. Tagged a shelf at 3378'. Began circulating and added 60-65 lbs. of sodium thiocyanate.
- 8-25-83 Reamed borehole to 3800' with 9-7/8" bit before pulling and changing to 9-7/8" bit with stabilizers (reamers). Reentered with the new reaming assembly and 9 drill collars above the reaming assembly.

- 8-26-83 Started to ream with new assembly at 3329'. Continued reaming to 3887'.
- 8-27-83 Continued reaming to 4039' until rig was shut down for brief maintenance. Continued reaming to 4134' (penetration rate = 2.7 min/ft).
- 8-28-83 Continued reaming to TD (4298.6'). Circulated hole for 6 hours. Changed the flow of the return fluid into alternate pit to lengthen the travel path to help settle cuttings. Pipe was laid for the TCWL. Drill pipe was removed from hole to allow geophysical logging by USGS and Dresser Atlas. USGS ran 3-arm caliper log, gamma ray log, and neutron density log.
- 8-29-83 USGS ran neutron porosity log. BOP was reinstalled on hole. Dresser Atlas ran dual laterolog and micro laterolog. USGS began running a sonic log. Sonic tool malfunctioned. An acoustic televiewer log was then run.
- 8-30-83 Received neutron porosity, caliper, gamma ray, and acoustic televiewer logs from USGS. Prepared rig for swabbing and testing. Began setting up packers. Started running tool to first test level (4178').
- 8-31-83 Continued running pipe and single packer into hole, bottom of packer located at 4178'. Packer would not inflate. Packer was removed and taken to shop for testing by Lynes.
- 9-1-83 Packer with repaired circulating valve was run down hole. Malfunction of the readout unit associated with the transducers mandated tripping out at 3900'. Repaired wiring and reentered hole. Circuit checked OK at 4178', but packer would not inflate.
- 9-2-83 Started to pull tubing and packer because packer would not inflate. Lynes corrected problem and assembly was again run down hole. J-slot would not catch for numerous attempts.
- 9-3-83 Continued attempting to latch J-slot. Twisting and raising of rods caused the wiring to be pulled from the transducer. Started tripping out. Lynes took tool into Hobbs for overhaul.
- 9-4-83 Reentered hole checking pressure sensor at intervals to assure that it was functioning. Tool run to 4178'. Packer was inflated to 1500 psi. Pressure stabilized between 2076-2077 psi. Swabbed hole down to 3800' water level. Shut-in tool opened for first flow period (FFL). Tool shut-in for FBU. Opened tool for SFL test. Shut-in tool for SBU test. Swabbed tubing during shut-in. Opened tool for slug test.
- 9-5-83 Terminated slug test at $P_2 = 1788$ psia. Started swabbing operation. Flow measurements and water samples taken during swab lifts.

- 9-6-83 Swabbing was completed and swabbing equipment was removed. Lynes crew began pulling packers. Preparing for testing in zone 4138' to 4171'.
- 9-7-83 Lynes completed DST J-tool straddle-packer assembly. Entered hole with equipment, performing circuit tests at 320' intervals. Set bottom of top packer at 4138'. Set up swabbing equipment and swabbed to about 4000'. FFL, FBU, SFL, SBU were completed and Slug test was started.
- 9-8-83 Running slug test at 4138' test level.
- 9-9-83 Running slug test at 4138' test level.
- 9-10-83 Completed slug test. Began swabbing operation.
- 9-11-83 Continuing swabbing operation. Water samples were taken. Moved the bottom of the top packer to 4100 feet. Filled tubing to set packer. Began swabbing process.
- 9-12-83 Completed swabbing and FFL, FBU, SFL, and SBU. Started slug test.
- 9-13-83 Running slug test.
- 9-14-83 Completed slug test. Began swabbing operation. Swabbing assembly parted from wireline when it hit top of tube.
- 9-15-83 Tripped out of hole to repair swabbing assembly. Packers inflated while tripping out of hole. Packers were deflated using another swabbing tool to reduce the head on the packer. Lower packer was damaged as it was pulled through the BOP. Lynes took packer to shop for repair. Ball bar sleeve also damaged.
- 9-16-83 Repaired packers were run into the hole. Circuit checks at various levels showed a short had occurred between the instrument and surface computer. Tool was pulled to check the systems electronics. The circuit checked at the surface. Started tripping in. Bottom of top packer set at 4044'. Commenced swabbing operation. Opened tool for FFL.
- 9-17-83 Closed tool for FBU. Continued FBU.
- 9-18-83 Continued FBU.
- 9-19-83 Terminated FBU. Tripped out of hole. Tripped into hole to set packers for series of DST tests in Salado Formation. Bottom packer (bridge plug, PIP) with Digital Memory Recorder (DMR) 312 suspended below, set at 2725'.
- 9-20-83 Tripped out of hole. Tripped in and inflated upper packer at 735'. Upper packer did not completely seat. Upper packer was moved to 765' and set. Began swabbing operation and DST-765 (765' level) Salado testing FFL, FBU, SFL, and SBU.
- 9-21-83 Continued SBU (DST-765).
- 9-22-83 Swabbed tubing. Terminated SBU (DST-765) and started slug test.

- 9-23-83 Slug test terminated. Lower and upper packers and DMR retrieved.
- 9-24-83 Sperry Sun performed directional survey. Tripped in and set packer (4039') for Bell Canyon Formation H₂O quality sampling. Began swabbing operation. Damaged wireline while entering hole for swabbing. Repaired wireline and continued swabbing.
- 9-25-83 Continued swabbing operation. Wireline parted from swabbing assembly and dropped to bottom. Pulled tubing and packer to repair. Lynes repaired assembly. Packer run back into hole. Packer could not be inflated as sinker bar still in tubing. Pulled tubing and packer.
- 9-26-83 Repaired assembly and tripped into hole. Set PIP 4041' below KB. Began swabbing operation (obtained samples).
- 9-27-83 Obtained samples and terminated swabbing (sodium thiocyanate = 1.9 mg/l).
- 9-28-83 Welded and completed well head assembly and tubing cap. Began demobilization.
- 9-29-83 Packed and shipped samples to lab. Completed demobilization.

DISTRIBUTION

DISTRIBUTION

U.S. Department of Energy, Headquarters
Office of Nuclear Waste Management
Washington, D.C. 20545

Lawrence Harmon, Program Manager (WIPP)
Wade Ballard, Director, Div. of Waste Isolation (2)

U.S. Department of Energy, Headquarters
Office of Defense Waste & By-Products
Washington, D.C. 20545

Dr. Goetz Oertel, Director (NE-320)

U.S. Department of Energy, Albuquerque Operations
P.O. Box 5400
Albuquerque, New Mexico 87185

J. M. McGough, Manager, WIPP Project Office (2)
D. Jackson, Director, Public Affairs Division

U.S. Department of Energy
Carlsbad WIPP Project Office
Room 113, Federal Building
Carlsbad, New Mexico 88220

U.S. Department of Energy
c/o Battelle Office of Nuclear Waste Isolation
505 King Avenue
Columbus, Ohio 43201

Jeff O. Neff

Battelle Memorial Institute
Office of Nuclear Waste Isolation
505 King Avenue
Columbus, Ohio 43201

S. Goldsmith, Manager
ONWI Library

Battelle Memorial Institute
Project Management Division
505 King Avenue
Columbus, Ohio 43201

Neal Carter, General Manager

DISTRIBUTION
(Continued)

D'Appolonia Consulting Engineers
2340 Alamo, S.E.
Albuquerque, New Mexico 87106

D. K. Shukla (25)
J. K. Register, for DOE/TIC (25)

Westinghouse Electric Corporation
P.O. Box 40039
Albuquerque, New Mexico 87196

G. L. Hohmann (15)

Bechtel National, Inc.
Fifty Beale Street
P.O. Box 3965
San Francisco, California 94119

D. L. Ledbetter
Dale Roberts

National Academy of Sciences, WIPP Panel

Frank L. Parker, Chairman
Department of Environmental and Water Resources
Engineering
Vanderbilt University
Nashville, Tennessee 37235

Konrad B. Krauskopf, Vice Chairman
Department of Geology
Stanford University
Stanford, California 94305

Karl P. Cohen, Member
Consultant
928 North California Avenue
Palo Alto, California 94303

Neville G. W. Cook, Member
Dept. of Material Sciences and Engineering
University of California at Berkeley
Hearst Mining Building, #320
Berkeley, California 94720

Fred M. Ernsberger, Member
250 Old Mill Road
Pittsburgh, Pennsylvania 15238

DISTRIBUTION
(Continued)

National Academy of Sciences, WIPP Panel (Continued)

Richard R. Parizek, Member
Department of Hydrogeology
Pennsylvania State University
University Park, Pennsylvania 16802

D'Arcy A. Shock, Member
233 Virginia
Ponca City, Oklahoma 74601

John W. Winchester, Member
Department of Oceanography
Florida State University
Tallahassee, Florida 32306

John T. Holloway
Senior Staff Officer
National Academy of Sciences
2101 Constitution Avenue, NW
Washington, D.C. 20418

WIPP Public Reading Room
Atomic Museum, Kirtland East AFB
Albuquerque, New Mexico 87185

Attention: Ms. Gwynn Schreiner

WIPP Public Reading Room
Carlsbad Municipal Library
101 S. Hallagueno Street
Carlsbad, New Mexico 88220

Attention: Lee Hubbard, Head Librarian

Thomas Brannigan Library
106 West Hadley Street
Las Cruces, New Mexico 88001

Attention: Don Dresp, Head Librarian

Roswell Public Library
301 North Pennsylvania Avenue
Roswell, New Mexico 88201

Attention: Ms. Nancy Langston

Hobbs Public Library
509 North Ship Street
Hobbs, New Mexico 88248

Ms. Marcia Lewis, Librarian

DISTRIBUTION
(Continued)

State of New Mexico
Environmental Evaluation Group
320 Marcy street
P.O. Box 968
Santa Fe, New Mexico 87503

Robert H. Neill, Director (2)

New Mexico Department of Energy & Minerals
P.O. Box 2770
Santa Fe, New Mexico 87501

P. Biderman, Secretary
Kasey LaPlante, Librarian

New Mexico State Geologist
P.O. Box 2860
Santa Fe, New Mexico 87501

Emery C. Arnold

New Mexico State Library
P.O. Box 1629
Santa Fe, New Mexico 87503

Ms. Ingrid Vollenhofer

New Mexico Tech
Martin Speer Memorial Library
Campus Street
Socorro, New Mexico 87801

Zimmerman Library
University of New Mexico
Albuquerque, New Mexico 87131

Ms. Vivian Zanier

USGS, Water Resources Division
505 Marquette, NW
Western Bank Building
Albuquerque, New Mexico 87102

J. W. Mercer (2)

USGS, Conservation Division
P.O. Box 1857
Roswell, New Mexico 88201

W. Melton

DISTRIBUTION
(Continued)

USGS, Special Projects Branch
Denver Federal Center
Mail Stop 954, Box 25046
Denver, Colorado 80225

R. P. Snyder (2)

New Mexico Bureau of Mines and Mineral Resources
Socorro, New Mexico 87801

F. E. Kottowski, Director (2)

Klaus Kuhn
Gesellschaft fuer Strahlen-und
Umweltforschung MBH Muenchen
Institut fuer Tieflagerung
Berliner Strasse 2
3392 Clausthal-Zellerfeld
Federal Republic of Germany

Klaus Echart Maass
Hahn-Meitner-Institut fuer Kernforschung
Glienicke Strasse 100
1000 Berlin 39
Federal Republic of Germany

Michael Langer
Bundesanstalt fuer Geowissenschaften und Rohstoffe
Postfach 510 153
3000 Hannover 51
Federal Republic of Germany

Helmut Rothemeyer
Physikalisch-Technische Bundesanstalt
Bundesallee 100
3300 Braunschweig
Federal Republic of Germany

Rolf-Peter Randl
Bundesministerium fuer Forschung und Technologie
Postfach 200 706
5300 Bonn 2
Federal Republic of Germany

Gayle Pawloski, L-222
Geologist CSDP
Lawrence Livermore Laboratory
Livermore, California 94550

DISTRIBUTION
(Continued)

U.S. Nuclear Regulatory Commission (3)
Division of Waste Management
Mail Stop 69755
Washington, D.C. 20555

Attention: J. Martin, M. Bell, H. Miller

Sandia National Laboratories
Albuquerque, New Mexico 87185

9730 W. D. Weart (15)